

# THEORY OF XRF

Getting acquainted  
with the principles

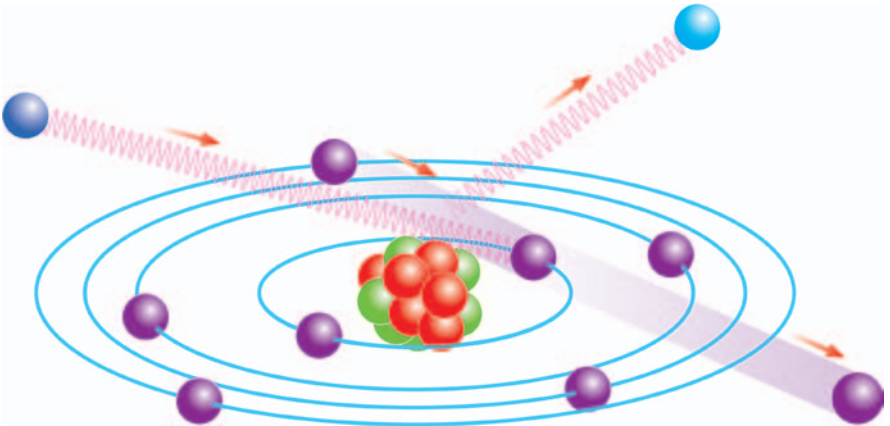
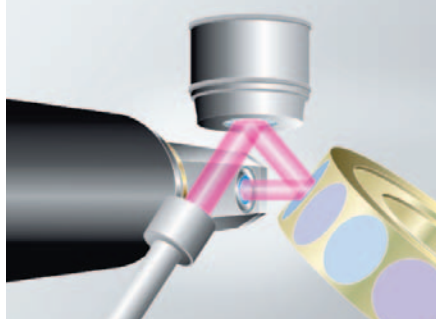

Peter Brouwer

# THEORY OF XRF

Getting acquainted with the principles

First published in The Netherlands under the title "Theory of XRF".  
Copyright © 2003 by PANalytical BV, The Netherlands.

All rights reserved. No part of this publication may be reproduced, stored in a retrieval system or transmitted in any form by any means electronic, mechanical, photocopying or otherwise without first obtaining written permission of the copyright owner.

This edition published in 2010 by:

**PANalytical B.V.**

Lelyweg 1, 7602 EA Almelo  
P.O. Box 13, 7600 AA Almelo  
The Netherlands

Tel: +31 (0)546 534 444

Fax: +31 (0)546 534 598

info@panalytical.com

**www.panalytical.com**

ISBN: 90-9016758-7

3<sup>rd</sup> edition

# THEORY OF XRF

Getting acquainted with the principles

*Peter N. Brouwer, born April 2, 1958 in Almelo, the Netherlands. He studied Applied Mathematics at the University of Technology in Enschede from where he graduated in 1985. In December 1985 he joined Philips Analytical, currently PANalytical, where he mainly worked on the development of analytical software modules in close cooperation with the Philips Research Laboratories in Eindhoven.*

*Another of his activities has been giving presentations and participating in XRF courses. That has resulted in this book being written. The objective was to make an easy to understand general introduction to XRF, without using difficult details and mathematics, that could be read and understood by people new in XRF.*

# Contents

<b>1.</b>	<b>Introduction</b> .....	<b>7</b>
<b>2.</b>	<b>What is XRF</b> .....	<b>8</b>
<b>3.</b>	<b>Basics of XRF</b> .....	<b>10</b>
3.1	What are X-rays .....	10
3.2	Interaction of X-rays with matter .....	10
3.3	Production of characteristic fluorescent radiation .....	11
3.4	Absorption and enhancement effects .....	14
3.5	Absorption and analysis depths .....	15
3.6	Rayleigh and Compton scatter .....	16
3.7	Geometry of XRF spectrometers .....	18
3.8	Polarization .....	18
<b>4.</b>	<b>The XRF spectrometer</b> .....	<b>20</b>
4.1	Small spot instruments. ....	21
4.1.1	EDXRF spectrometers with 2D optics .....	21
4.1.2	EDXRF spectrometers with 3D optics .....	23
4.2	WDXRF spectrometers .....	24
4.3	Comparison of EDXRF and WDXRF spectrometers .....	26
4.4	X-ray tubes .....	27
4.5	Secondary targets. ....	29
4.5.1	Fluorescent targets. ....	29
4.5.2	Barkla targets. ....	29
4.5.3	Bragg targets .....	29
4.6	Detectors and multi channel analyzers. ....	30
4.7	Multi channel analyzer (MCA). ....	30
4.7.1	ED solid-state detector. ....	31
4.7.2	Gas-filled detector .....	32
4.7.3	Scintillation detector .....	33
4.8	Escape peaks and pile-up peaks .....	33
4.9	Comparison of different detectors .....	34
4.10	Filters. ....	35
4.11	Diffraction crystals and collimators. ....	35
4.12	Lens .....	37
4.12	Masks .....	37
4.13	Spinner .....	37
4.14	Vacuum and helium system. ....	38
<b>5.</b>	<b>XRF analysis</b> .....	<b>39</b>
5.1	Sample preparation .....	39
5.1.1	Solids. ....	39
5.1.2	Powders .....	39
5.1.3	Beads. ....	40

5.1.4	Liquids.....	40
5.1.5	Material on filters .....	40
5.2	XRF measurements.....	40
5.2.1	Optimum measurement conditions .....	40
5.3	Qualitative analysis in EDXRF .....	41
5.3.1	Peak search and peak match.....	41
5.3.2	Deconvolution and background fitting .....	42
5.4	Qualitative analysis in WDXRF .....	43
5.4.1	Peak search and peak match.....	43
5.4.2	Measuring peak height and background subtraction.....	43
5.4.3	Line overlap correction .....	44
5.5	Counting statistics and detection limits .....	45
5.6	Quantitative analysis in EDXRF and WDXRF .....	47
5.6.1	Matrix effects and matrix correction models.....	47
5.6.2	Line overlap correction .....	53
5.6.3	Drift correction.....	54
5.6.4	Thin and layered samples .....	54
5.7	Analysis methods .....	55
5.7.1	Balance compounds .....	55
5.7.2	Normalization.....	56
5.8	Standardless analysis .....	56
6.	<b>Recommended literature.....</b>	<b>57</b>
7.	<b>Index.....</b>	<b>58</b>

# 1. Introduction

This booklet gives a general introduction to X-Ray fluorescence (XRF) spectrometry and XRF analysis. It explains simply how a spectrometer works and how XRF analysis is done. It is intended for people new to the field of XRF analysis. Difficult mathematical equations are avoided and the booklet requires only a basic knowledge of mathematics and physics.

The booklet is not dedicated to one specific type of spectrometer or one application area, but aims to give a broad overview of the main spectrometer types and applications.

Chapter 2 briefly explains XRF and its benefits. Chapter 3 explains the physics of XRF, and Chapter 4 describes how this physics is applied to spectrometers and their components. Chapter 5 explains how an XRF analysis is done. It describes the process of sample taking, measuring the sample and calculating the composition from the measurement results.

Finally, Chapter 6 gives a list of recommended literature for further information on XRF analysis.



## 2. What is XRF

XRF is an analytical method to determine the chemical composition of all kinds of materials. The materials can be in solid, liquid, powder, filtered or other form. XRF can also sometimes be used to determine the thickness and composition of layers and coatings.

The method is fast, accurate and non-destructive, and usually requires only a minimum of sample preparation. Applications are very broad and include the metal, cement, oil, polymer, plastic and food industries, along with mining, mineralogy and geology, and environmental analysis of water and waste materials. XRF is also a very useful analysis technique for research and pharmacy.

Spectrometer systems can be divided into two main groups: energy dispersive systems (EDXRF) and wavelength dispersive systems (WDXRF), explained in more detail later. The elements that can be analyzed and their detection levels mainly depend on the spectrometer system used. The elemental range for EDXRF goes from sodium to uranium (Na to U). For WDXRF it is even wider, from beryllium to uranium (Be to U). The concentration range goes from (sub) ppm levels to 100%. Generally speaking, the elements with high atomic numbers have better detection limits than the lighter elements.

The precision and reproducibility of XRF analysis is very high. Very accurate results are possible when good standard specimens are available, but also in applications where no specific standards can be found.

The measurement time depends on the number of elements to be determined and the required accuracy, and varies between seconds and 30 minutes. The analysis time after the measurement is only a few seconds.

Figure 1 shows a typical spectrum of a soil sample measured with EDXRF - the peaks are clearly visible. The positions of the peaks determine the elements present in the sample, while the heights of the peaks determine the concentrations.

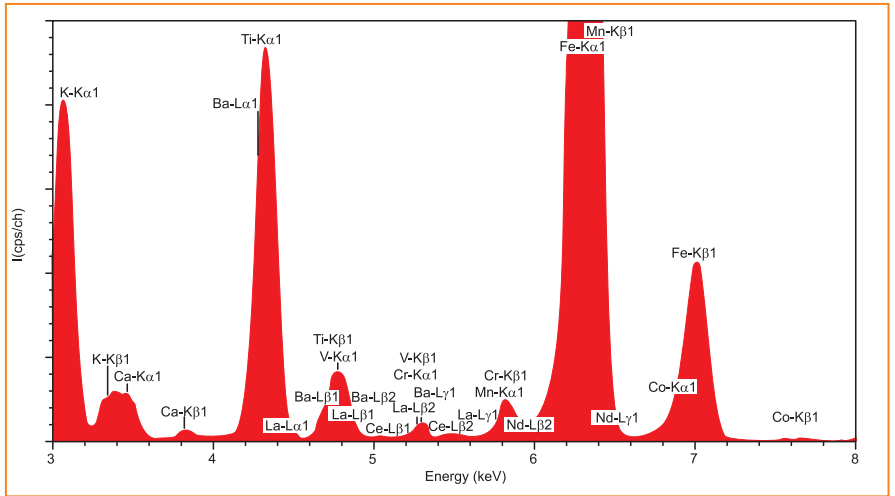

Figure 1. Typical spectrum of a soil sample measured with an EDXRF spectrometer

### 3. Basics of XRF

In XRF, X-rays produced by a source irradiate the sample. In most cases, the source is an X-ray tube but alternatively it could be a synchrotron or a radioactive material. The elements present in the sample will emit fluorescent X-ray radiation with discrete energies (equivalent to colors in optical light) that are characteristic for these elements. A different energy is equivalent to a different color. By measuring the energies (determining the colors) of the radiation emitted by the sample it is possible to determine which elements are present. This step is called qualitative analysis. By measuring the intensities of the emitted energies (colors) it is possible to determine how much of each element is present in the sample. This step is called quantitative analysis.

#### 3.1 What are X-rays

X-rays can be seen as electromagnetic waves with their associated wavelengths, or as beams of photons with associated energies. Both views are correct, but one or the other is easier to understand depending on the phenomena to be explained. Other electromagnetic waves include light, radio waves and  $\gamma$ -rays. Figure 2 shows that X-rays have wavelengths and energies between  $\gamma$ -rays and ultra violet light. The wavelengths of X-rays are in the range from 0.01 to 10 nm, which corresponds to energies in the range from 0.125 to 125 keV. The wavelength of X-rays is inversely proportional to its energy, according to  $E \cdot \lambda = hc$ . E is the energy in keV and  $\lambda$  the wavelength in nm. The term  $hc$  is the product of Planck’s constant and the velocity of light and has, using keV and nm as units, a constant value of 1.23985.

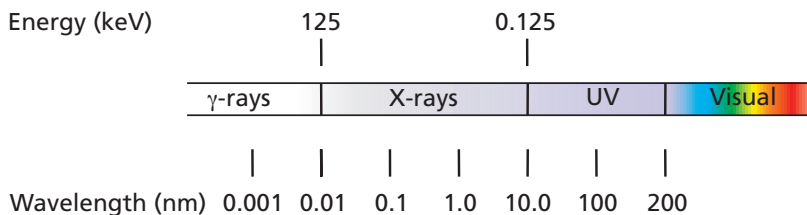

Figure 2. X-rays and other electromagnetic radiation

#### 3.2 Interaction of X-rays with matter

There are three main interactions when X-rays contact matter: Fluorescence, Compton scatter and Rayleigh scatter (see Figure 3). If a beam of X-ray photons is directed towards a slab of material a fraction will be transmitted through, a fraction is absorbed (producing fluorescent radiation) and a fraction is scattered back. Scattering can occur with a loss of energy and without a loss of energy. The first is known as Compton scatter and the second Rayleigh scatter. The fluorescence

and the scatter depend on the thickness ( $d$ ), density ( $\rho$ ) and composition of the material, and on the energy of the X-rays. The next sections will describe the production of fluorescent radiation and scatter.

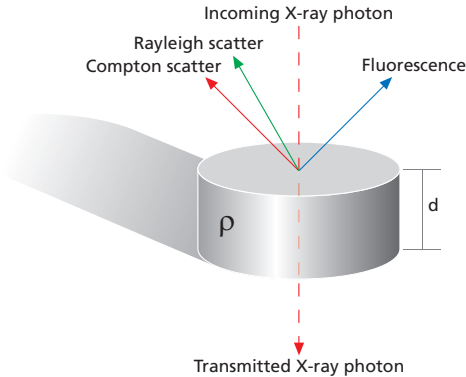

Figure 3. Three main interactions of X-rays with matter

### 3.3 Production of characteristic fluorescent radiation

The classical model of an atom is a nucleus with positively charged protons and non-charged neutrons, surrounded by electrons grouped in shells or orbitals. The innermost shell is called the K-shell, followed by L-shells, M-shells etc. as one moves outwards. The L-shell has 3 sub-shells called  $L_I$ ,  $L_{II}$  and  $L_{III}$ . The M-shell has 5 subshells  $M_I$ ,  $M_{II}$ ,  $M_{III}$ ,  $M_{IV}$  and  $M_V$ . The K-shell can contain 2 electrons, the L-shell 8 and the M-shell 18. The energy of an electron depends on the shell it occupies, and on the element to which it belongs. When irradiating an atom, particles such as X-ray photons and electrons with sufficient energy can expel an electron from the atom (Figure 4).

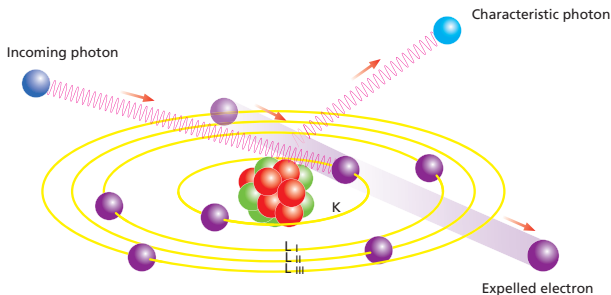

Figure 4. Production of characteristic radiation

This produces a 'hole' in a shell, in the example (Figure 4) a hole in the K-shell, putting the atom in an unstable excited state with a higher energy. The 'hole' in

the shell is also called the initial vacancy. The atom wants to restore the original configuration, and this is done by transferring an electron from an outer shell such as the L-shell to the hole in the K-shell. An L-shell electron has a higher energy than a K-shell electron, and when an L-shell electron is transferred to the K-shell, the energy surplus can be emitted as an X-ray photon. In a spectrum, this is seen as a line.

The energy of the emitted X-rays depends on the difference in energy between the shell with the initial hole and the energy of the electron that fills the hole (in the example, the difference between the energy of the K and the L shell). Each atom has its specific energy levels, so the emitted radiation is characteristic of that atom. An atom emits more than a single energy (or line) because different holes can be produced and different electrons can fill these. The collection of emitted lines is characteristic of the element and can be considered a fingerprint of the element.

To expel an electron from an atom, the X-rays must have a higher energy level than the binding energy of the electron. If an electron is expelled, the incoming radiation is absorbed, and the higher the absorption the higher the fluorescence. If, on the other hand, the energy is too high, many photons will 'pass' the atom and only a few electrons will be removed. Figure 5 shows that high energies are hardly absorbed and produce low fluorescence. If the energy of the incident photons is lower and comes closer to the binding energy of the K-shell electrons, more and more of the radiation is absorbed. The highest yield is reached when the energy of the photon is just above the binding energy of the electron to be expelled. If the energy becomes lower than the binding energy, a jump or edge can be seen: the energy is too low to expel electrons from the corresponding shell, but is too high to expel electrons from the lower energetic shells. The figures show the K-edge corresponding to the K-shell, and three L-edges corresponding with the  $L_{\text{I}}$ ,  $L_{\text{II}}$ - and  $L_{\text{III}}$ -shells.

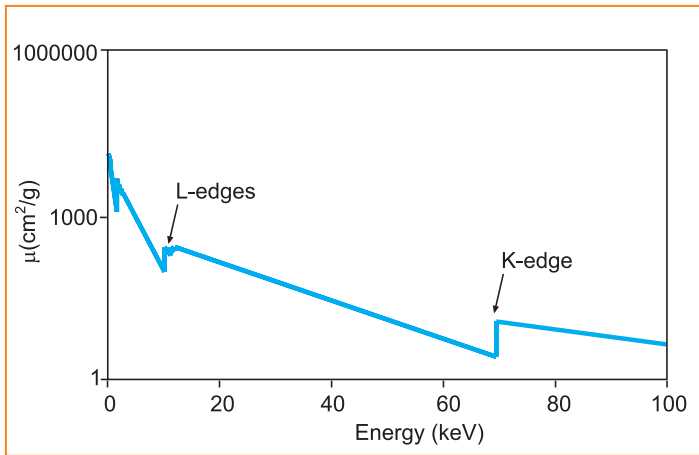

Figure 5. Absorption versus energy

Not all initial vacancies created by the incoming radiation produce fluorescent photons. Emission of an Auger electron is another process that can take place. The fluorescent yield is the ratio of the emitted fluorescent photons and the number of initial vacancies. Figure 6 shows the fluorescence yield for K- and L-lines as a function of the atomic number Z. The figure clearly shows that the yield is low for the very light elements, explaining why it is so difficult to measure these elements.

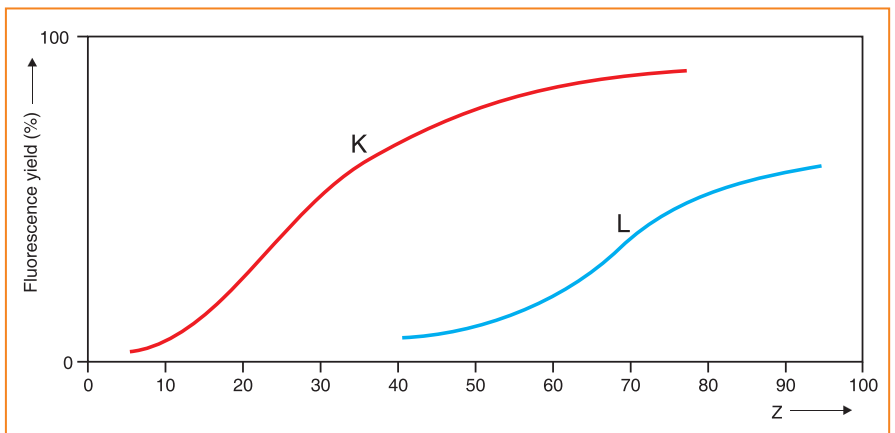

Figure 6. Fluorescence yield for K and L electrons

There are several ways to indicate different lines. The Siegbahn and IUPAC notations are the two most often found in the literature. The Siegbahn notation indicates a line by the symbol of an element followed by the name of the shell where the initial hole is plus a Greek letter ( $\alpha, \beta, \gamma$  etc.) indicating the relative

intensity of the line. For example, Fe  $K\alpha$  is the strongest iron line due to an expelled K electron. The Siegbahn notation however does indicate which shell the electron comes from that fills the hole. In the IUPAC notation, a line is indicated by the element and the shell where the initial hole was, followed by the shell where the electron comes from that fills this hole. For example, Cr  $KL_{III}$  is chromium radiation due to a hole produced in the K-shell filled by an electron in the  $L_{III}$ -shell. Generally, K-lines are more intense than L-lines, which are more intense than M-lines, and so on. Quantum mechanics teaches that not all transitions are possible, for instance a transition from the  $L_I$ - to the K-shell. Figure 7 gives an overview of the most important lines with their transitions in Siegbahn notation.

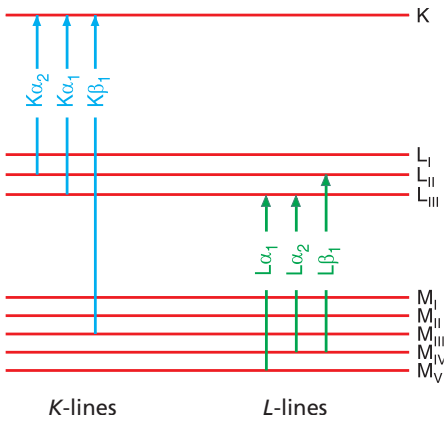

Figure 7. Major lines and their transition

### 3.4 Absorption and enhancement effects

To reach the atoms inside the sample, the X-rays have to pass through the layer above it, and this layer will absorb a part of the incoming radiation. The characteristic radiation produced also has to pass through this layer to leave the sample, and again part of the radiation will be absorbed.

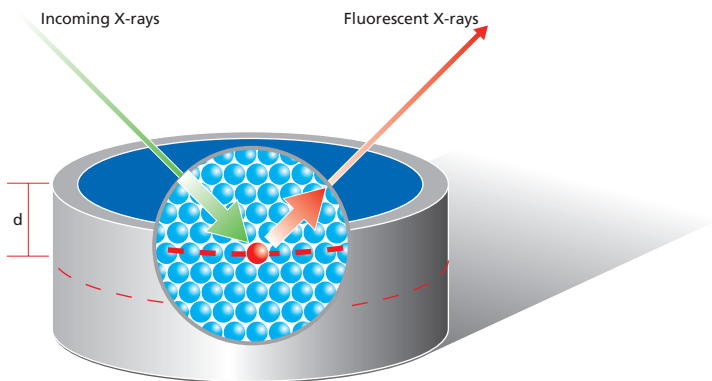

Figure 8. Absorption of incoming and fluorescent X-rays

The magnitude of the absorption depends on the energy of the radiation, the path length  $d$  of the atoms that have to be passed, and the density of the sample. The absorption increases as the path length, density and atomic number of the elements in the layer increase, and as the energy of the radiation decreases. The absorption can be so high that elements deep in the sample are not reached by the incoming radiation or the characteristic radiation can no longer leave the sample. This means that only elements close to the surface will be measured.

The incoming radiation is made up of X-rays, and the characteristic radiation emitted by the atoms in the sample itself is also X-rays. These fluorescent X-rays are sometimes able to expel electrons from other elements in the sample. This, as with the X-rays coming from the source, results in fluorescent radiation. The characteristic radiation produced directly by the X-rays coming from the source is called primary fluorescence, while that produced in the sample by primary fluorescence of other atoms is called secondary fluorescence.



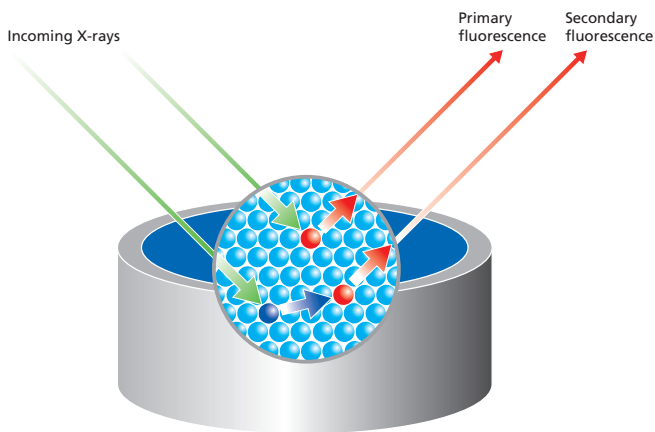

Figure 9. Primary and secondary fluorescence

A spectrometer will measure the sum of the primary and secondary fluorescence, and it is impossible to distinguish between the two contributions. The contribution of secondary fluorescence to the characteristic radiation can be significant (of the order of 20%). Similarly, tertiary and even higher order radiation can occur. In almost all practical situations these are negligible, but in very specific cases can reach values of 3%.

### 3.5 Absorption and analysis depths

As the sample gets thicker and thicker, more and more radiation is absorbed. Eventually radiation produced in the deeper layers of the sample is no longer able to leave the sample. When this limit is reached depends on the material and on the energy of the radiation.

Table 1 gives the approximate analysis depth in various materials for three lines with different energies. Mg  $K\alpha$  has an energy of 1.25 keV, Cr  $K\alpha$  5.41 keV and Sn  $K\alpha$  25.19 keV.

Material	Mg $K\alpha$	Cr $K\alpha$	Sn $K\alpha$
Lead	0.7	4.5	55
Iron	1	35	290
SiO <sub>2</sub>	8	110	0.9 cm
Li <sub>2</sub> B <sub>4</sub> O <sub>7</sub>	13	900	4.6 cm
H <sub>2</sub> O	16	1000	5.3 cm

Table 1. Analysis depth in  $\mu\text{m}$  (unless indicated otherwise) for three different lines and various materials

When a sample is measured, only the atoms within the analysis depth are analyzed. If samples and standards with various thicknesses are analyzed, the thickness has to be taken into account.

### 3.6 Rayleigh and Compton scatter

A part of the incoming X-rays is scattered (reflected) by the sample instead of producing characteristic radiation. Scatter happens when a photon hits an electron and bounces away. The photon loses a fraction of its energy, which is taken in by the electron as shown in Figure 10. It can be compared with one billiard ball colliding with another. After the collision, the first ball loses a part of its energy to the ball that was hit. The fraction that is lost depends on the angle at which the electron (ball) was hit. This type of scatter is called Compton or incoherent scatter.

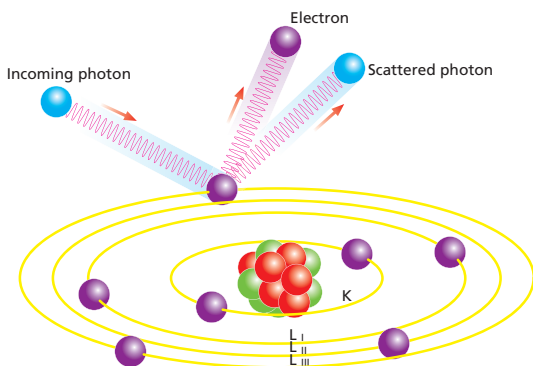

Figure 10. Compton scatter

Another phenomenon is Rayleigh scatter. This happens when photons collide with strongly bound electrons. The electrons stay in their shell but start oscillating at the frequency of the incoming radiation. Due to this oscillation, the electrons emit radiation at the same frequency (energy) as the incoming radiation. This gives the impression that the incoming radiation is reflected (scattered) by the atom. This type of scatter is called Rayleigh or coherent scatter.

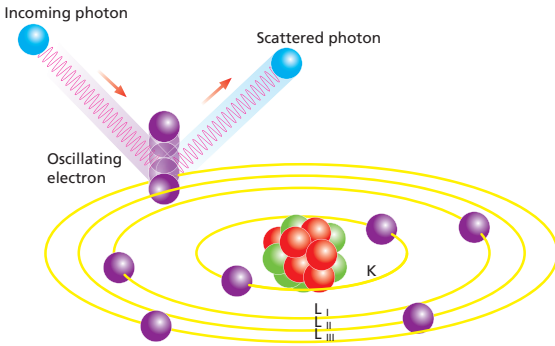

Figure 11. Rayleigh scatter

Samples with light elements give rise to high Compton scatter and low Rayleigh scatter because they have many loosely bound electrons. When the elements get heavier the scatter reduces. For the heavy elements, the Compton scatter disappears completely, and only Rayleigh scatter remains. Figure 12 shows the Compton and Rayleigh scatters for lead (a heavy element) and for perspex (light elements). The spread of energy in the Compton scatter is larger than for Rayleigh scatter; in a spectrum this can be observed by the Compton peak being wider than the Rayleigh peak.

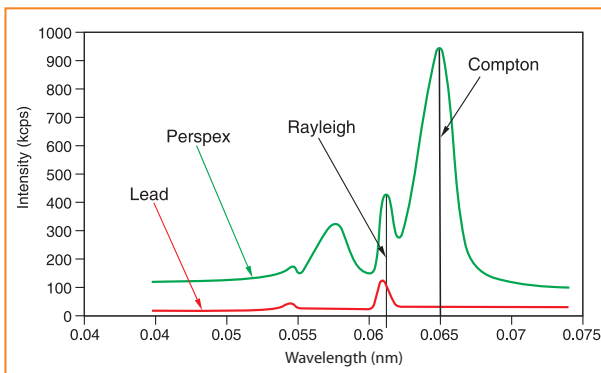

Figure 12. Compton and Rayleigh scatter for light and heavy elements

### 3.7 Geometry of XRF spectrometers

EDXRF spectrometers can be divided into spectrometers with 2D and 3D optics. Both types have a source and an energy dispersive detector, but the difference is found in the X-ray optical path. For 2D spectrometers the X-ray path is in one plane, so in 2 dimensions. For the 3D spectrometers, the path is not limited to one plane but involves 3 dimensions.

### 3.8 Polarization

X-rays are electromagnetic waves with electric and magnetic components  $E$  and  $B$ . This discussion is limited to the electrical component  $E$  but also holds for the magnetic component  $B$ . The amplitude of the electromagnetic waves corresponds to the intensity of the X-rays. Electromagnetic waves are transversal waves, which means that the electrical component is perpendicular to the propagation direction. This is similar to waves in water. If a stone is thrown into water, the waves are vertical but the propagation direction is horizontal.

X-rays are said to be linear polarized if the electrical components are all in one plane as shown in Figure 13. If the electrical component has no preferred direction then the waves are called non-polarized.

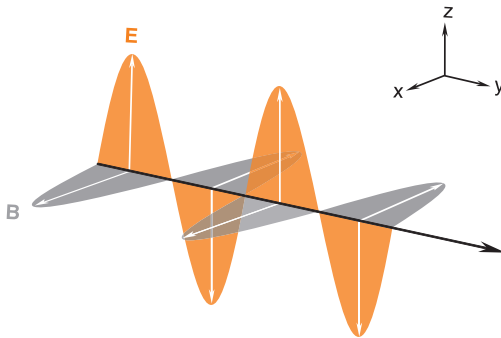

Figure 13. X-rays polarized in vertical direction

An electrical component  $E$  pointing in any direction can always be resolved into two perpendicular directions. Figure 14 shows how a component is resolved into a vertical and a horizontal direction.

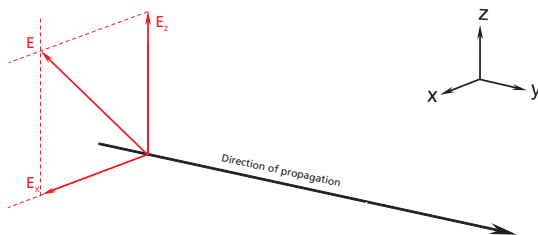

Figure 14. Electrical component resolved in horizontal and vertical components

If non-polarized X-rays are reflected (scattered) by a specimen through  $90^\circ$ , the reflected X-rays will be polarized in one direction. Figure 15 shows that the

vertical electrical component is not reflected because this would point in the new propagation direction. What remains after one reflection is the horizontal component alone, and the scattered X-rays are polarized horizontally.

Figure 15 (bottom) shows what happens if the X-rays are scattered again but perpendicular to the previous direction. In the second reflection the horizontal component is not reflected because it would point in the new propagation direction. Nothing is left from the incoming radiation after two perpendicular reflections. This feature is used in EDXRF spectrometers to eliminate the background profile from a spectrum.

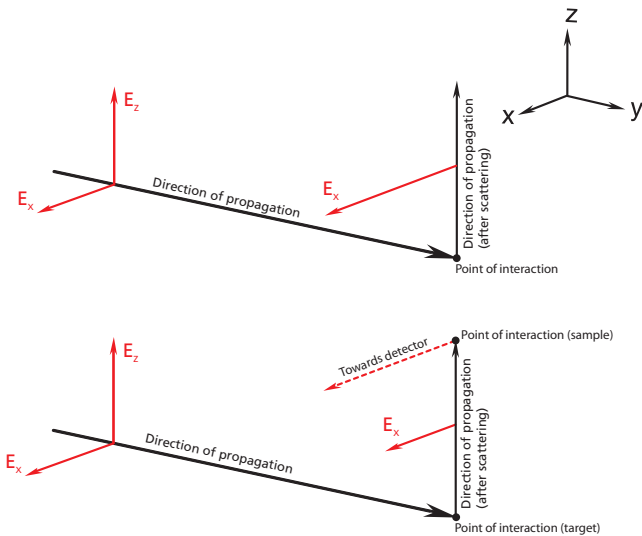

Figure 15. Polarization after 1 and 2 scattering events

## 4. The XRF spectrometer

The basic concept for all spectrometers is a source, a sample and a detection system. The source irradiates a sample, and a detector measures the radiation coming from the sample.

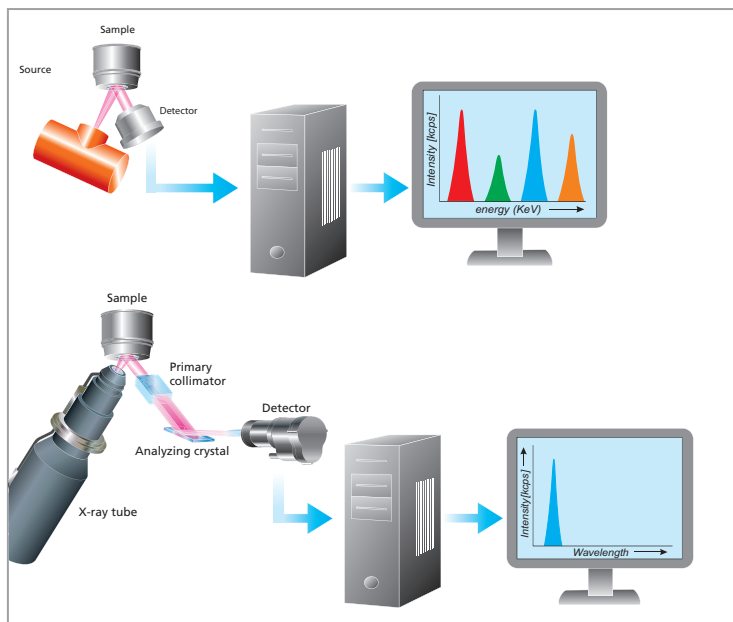

Figure 16. Basic designs of EDXRF and WDXRF spectrometers

In most cases the source is an X-ray tube, and this booklet will only discuss such spectrometers (alternative types use a radioactive source or synchrotron). Spectrometer systems are generally divided into two main groups: energy dispersive systems (EDXRF) and wavelength dispersive systems (WDXRF). The difference between the two systems is found in the detection system.

EDXRF spectrometers have a detector that is able to measure the different energies of the characteristic radiation coming directly from the sample. The detector can separate the radiation from the sample into the radiation from the elements in the sample. This separation is called dispersion.

WDXRF spectrometers use an analyzing crystal to disperse the different energies. All radiation coming from the sample falls on the crystal. The crystal diffracts the different energies in different directions, similar to a prism that disperses different colors in different directions. The next sections explain the differences between the spectrometer types in more detail, followed by a description of all the individual spectrometer components.

## 4.1 Small spot instruments

In most XRF applications the size of the samples is around one centimeter giving the average composition of the samples. For some application the local composition at different spots on the sample is required like spots on a chip wafers or on magnetic disks. For other applications, only a very small sample is available like a sliver of paint. Typical required spot diameters are between 50  $\mu\text{m}$  and a few millimeters.

An option is to use pinholes between tube and sample and/or between sample and detector but the sensitivity is very low. In most cases, lenses are used for small spot analysis.

Figure 17 shows three possible optical paths using lenses, each having its advantages and disadvantages. The first optical path has the advantage that only the spot of interest is irradiated, the sensitivity is relatively high and alignment is not difficult. A disadvantage is that for optimal excitation a point source is required.

The second option has a good sensitivity, is not difficult to align, but the sample is irradiated outside the spot of interest.

The last option has the best spatial performance but has a low sensitivity and is very difficult to align.

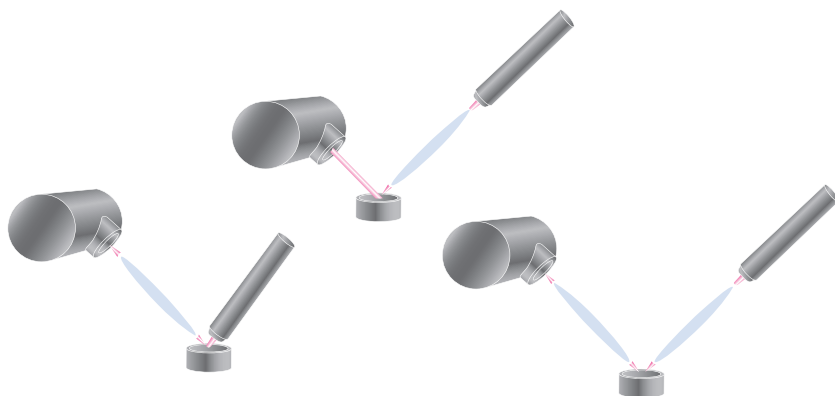

Figure 17. Possible optical paths using lenses

#### 4.1.1 EDXRF spectrometers with 2D optics

The simplest configuration is shown in Figure 18 (left). The tube irradiates the sample directly, and the fluorescence coming from the sample is measured with an energy dispersive detector. An alternative is to place a secondary target between the tube and the sample as shown in Figure 18 (right). The tube irradiates the secondary target and this target will emit its characteristic radiation. The advantage of a secondary target is that it emits (almost) monochromatic radiation but its disadvantage is that energy is lost. Using different secondary targets can achieve optimum excitation for all elements.

The detector is able to measure the energies of the incoming radiation directly. Besides the fluorescence, scattered tube radiation will reach the detector, which results in a background profile and background noise. Due to this background, it is difficult to detect low peaks and as a result to determine low concentrations. The X-ray path is in one plane, so is 2-dimensional, and the X-ray optics are called 2D optics.

Figure 19 shows a typical spectrum of a soil sample measured with an EDXRF spectrometer with 2D optics. The next section discusses a spectrum of the same sample but measured with 3D optics, showing that the background with 3D optics is significantly lower.

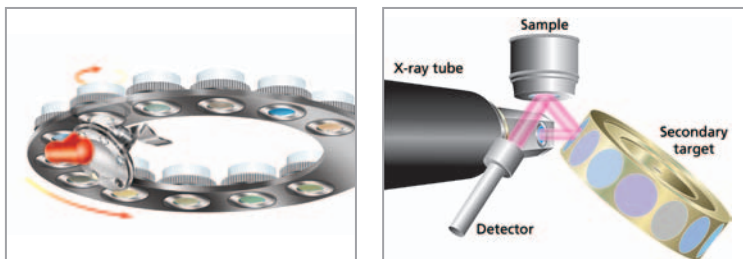

Figure 18. Energy dispersive spectrometers with 2D optics and direct excitation (left) and polarized optics (3D) with indirect excitation (right)



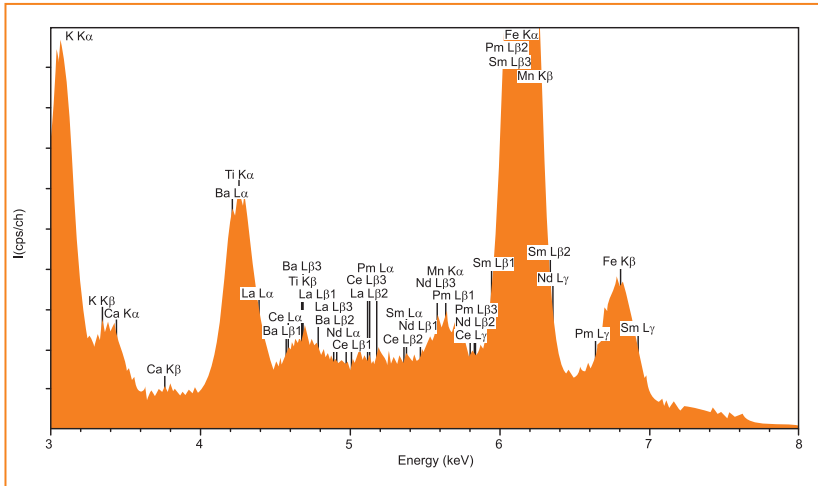

Figure 19. Typical spectrum of a soil sample measured with EDXRF spectrometer having 2D optics and direct excitation

#### 4.1.2 EDXRF spectrometers with 3D optics

Figure 20 shows an EDXRF spectrometer using 3D optics. The X-ray path is not in one plane but in two perpendicular planes, and the optics for this type of spectrometers are called 3D optics. The tube irradiates a secondary target which emits its characteristic X-rays and scatters a part of the incoming X-rays. The radiation coming from the target is used to irradiate the sample, so for the sample the target behaves like a source. The sample emits its characteristic radiation, which is measured by an energy dispersive detector.

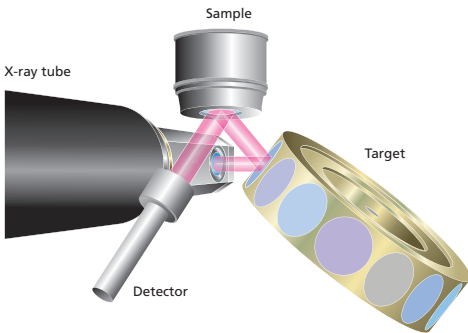

Figure 20. Energy dispersive spectrometer with 3D optics and indirect excitation

The advantage of this geometry is that scattered tube radiation cannot reach the detector because of polarization. To reach the detector, the tube radiation must scatter in 2 perpendicular directions, but as explained in Section 3.7 the X-rays vanish after two perpendicular reflections. As a consequence, the radiation coming

from the tube will not reach the detector. This will result in a very low background to the spectrum and makes it possible to detect very weak peaks, and hence to determine very low concentrations.

The characteristic radiation of the target is partly scattered by the sample and reaches the detector. This radiation is scattered in only one direction and so it will not vanish. Figure 21 shows a typical spectrum of a soil sample measured with an EDXRF spectrometer with 3D optics. It is a spectrum of the same sample as in Section 4.1.1 - the background to a spectrum measured with 3D optics is significantly lower than the same spectrum measured with 2D optics.

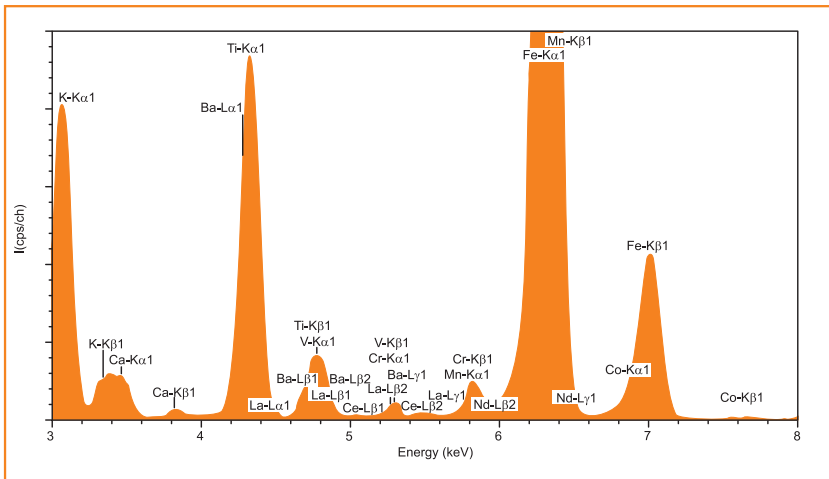

Figure 21. Typical spectrum of a soil sample measured with an EDXRF spectrometer having 3D optics and indirect excitation

## 4.2 WDXRF spectrometers

The first part of a WDXRF spectrometer is equivalent to an EDXRF spectrometer with 2D optics and without a secondary target. The tube irradiates a sample and the radiation coming from the sample is detected. The detection system is however different from EDXRF spectrometers.

For WDXRF, the detection system is a set of collimators, a diffraction crystal and a detector. The X-rays coming from the sample fall on the crystal, and the crystal diffracts (reflects) the X-rays with different wavelengths (energies) in different directions. (This is equivalent to a prism that separates white light into all the different colors). By placing the detector at a certain angle, the intensity of X-rays with a certain wavelength can be measured. It is also possible to mount the detector on a goniometer and move it through an angular range to measure the intensities of many different wavelengths. Spectrometers that use a moving detector on a goniometer are called sequential spectrometers because

they measure the intensities of the different wavelengths one after another. Simultaneous spectrometers (as shown in Figure 23) are equipped with a set of fixed detection systems. Each detection system has its crystal and detector, and each system measures the radiation of a specific element. The intensities are measured all at the same time, explaining why these are called simultaneous spectrometers. Combined systems having a moving detector and fixed detectors are also manufactured.

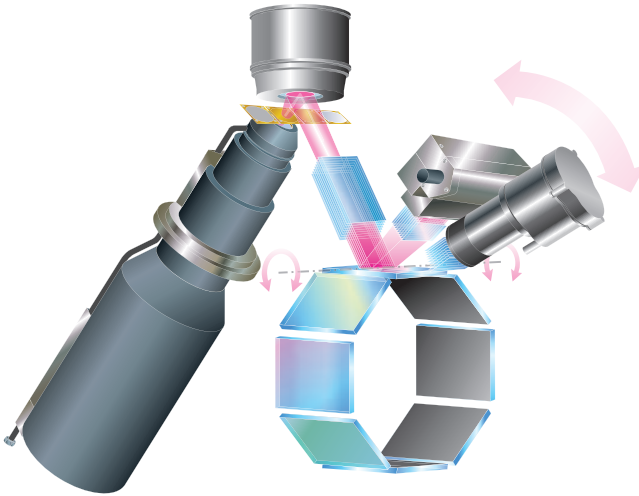

Figure 22. Construction of wavelength dispersive spectrometer with 2D optics and direct excitation

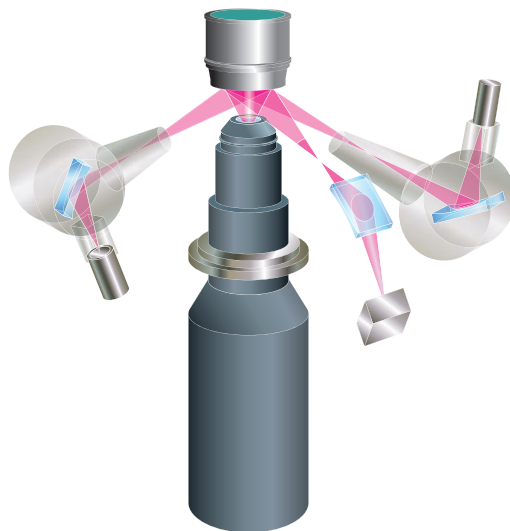

Figure 23. Simultaneous WDXRF spectrometer with crystals and detectors for different elements

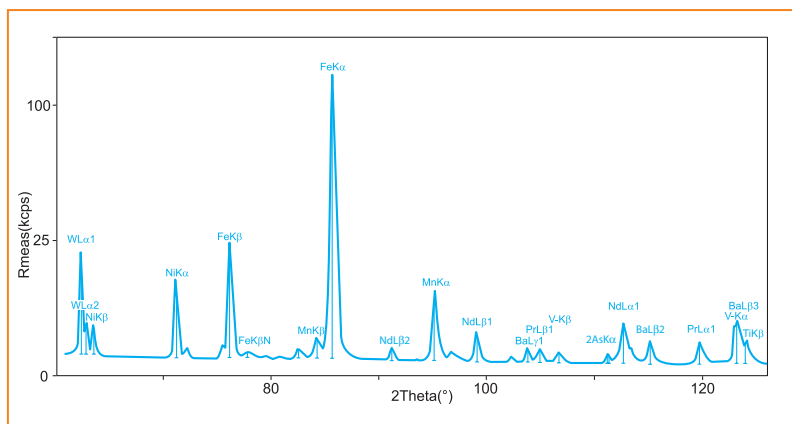

Figure 24. Typical spectrum measured with WDXRF spectrometer having 2D optics and direct excitation

### 4.3 Comparison of EDXRF and WDXRF spectrometers

EDXRF and WDXRF spectrometers have their advantages and disadvantages (Table 2).

	EDXRF	WDXRF
Elemental range	Na .. U (sodium .. uranium)	Be .. U (beryllium .. uranium)
Detection limit	Less optimal for light elements Good for heavy elements	Good for Be and all heavier elements
Sensitivity	Less optimal for light elements Good for heavy elements	Reasonable for light elements Good for heavy elements
Resolution	Less optimal for light elements Good for heavy elements	Good for light elements Less optimal for heavy elements
Costs	Relatively inexpensive	Relatively expensive
Power consumption	5 .. 1000 W	200 .. 4000 W
Measurement	Simultaneous	Sequential/simultaneous
Critical moving parts	No	Crystal, goniometer

Table 2. Comparison of EDXRF and WDXRF spectrometers

### 4.4 X-ray tubes

The basic design of an X-ray tube is shown in Figure 25. It contains a filament (wire) and an anode (target) placed in a vacuum housing. An electrical current heats up the filament and electrons are emitted. A high voltage (20..100 kV) is applied across the filament and the anode, and this high voltage accelerates the electrons towards the anode. When the electrons hit the anode they are decelerated, which causes the emission of X-rays. This radiation is called Bremsstrahlung ('Brems' is German for decelerate, 'strahlung' for radiation). The energy and intensity of the emitted X-rays is uniform, but a spectrum of energies each with its own intensity is emitted. This part of the spectrum is often called the continuum, because it is a continuous band of emitted energies.

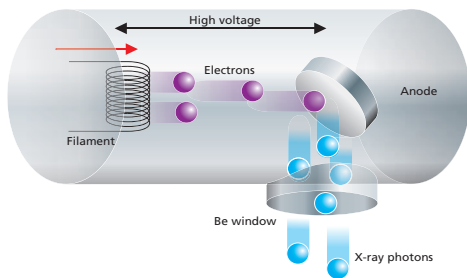

Figure 25. Basic design of a side window X-ray tube

A fraction of the electrons that hit the atoms in the anode will expel electrons from these atoms, causing emission of characteristic radiation as explained in Section 3.3. The energy of this radiation is determined by the element(s) in the anode.

The X-rays emitted by the anode can leave the tube through a beryllium (Be) window. Figure 26 shows a typical spectrum of a tube with gadolinium (Gd) anode operated at 30 kV. It shows the continuum, and the characteristic L-lines of Gd. The energy of the X-rays emitted cannot be higher than the applied voltage of 30 kV, and the X-rays with very low energies are not capable of passing through the Be window.

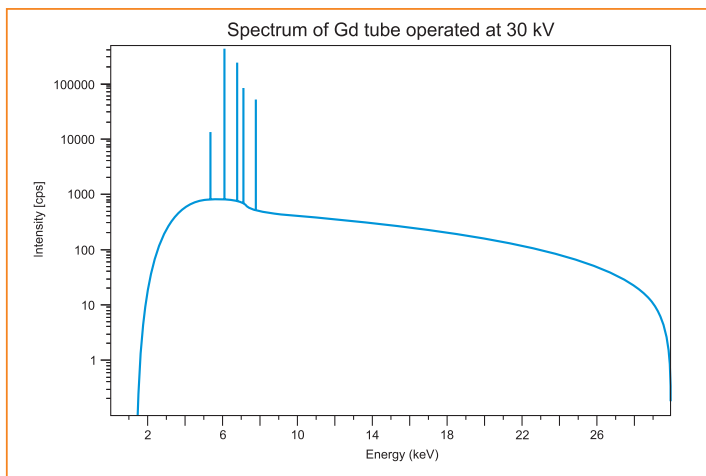

Figure 26. Emitted spectrum of a Gd tube operated at 30 kV

The continuum of an X-ray tube depends on the applied kV, the mA, and on the material used for the anode as shown in Figure 27.

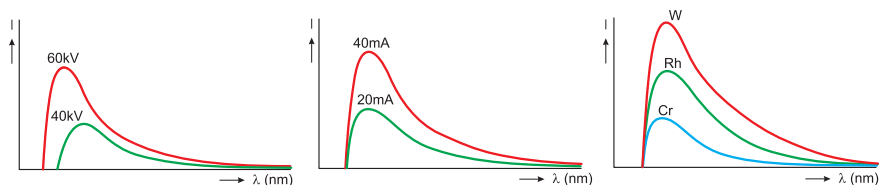

Figure 27. An X-ray tube's continuum depends on the applied kV, the mA and the anode material.

These tubes are called side window tubes because the Be window is on the side of the tube housing. It is also possible to rearrange the filament and the anode, and have a window at the end of the tube (an end window tube). An alternative design is shown in Figure 28. The electrons hit the anode on one side, the X-rays pass through the anode leaving it at the opposite side, and the radiation leaves the tube through the Be window. These tubes are called target transmission tubes.

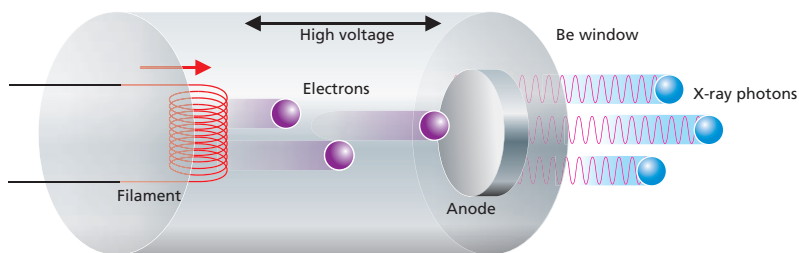

Figure 28. Design of a target transmission tube

## 4.5 Secondary targets

A secondary target is irradiated by a source and emits its characteristic radiation in a similar way to the target (anode) in the tube. It will also scatter a part of the incoming radiation. The target acts as a source, and the radiation coming from the target is used to irradiate the sample. There are three types of secondary targets: Fluorescent targets, Barkla targets and Bragg targets.

### 4.5.1 Fluorescent targets

Fluorescent targets use the fluorescence of elements in the target to excite the sample. These targets also scatter the tube radiation, but the fluorescence dominates. Scatter is low because the targets predominantly contain heavy elements.

The tube irradiates the target, and the element(s) in the target emit their characteristic fluorescent radiation. This radiation falls on the sample, causing fluorescent radiation. To achieve the highest fluorescence in the sample, the energy of the X-rays coming from the target must be just above the binding energy of the electrons of the elements in the sample. Spectrometers can be equipped with a set of different targets, and optimum fluorescence is achieved by selecting the correct target.

### 4.5.2 Barkla targets

Barkla targets use scattered tube radiation to excite the sample. These targets also fluoresce but the energy or intensity of these lines is too low to excite elements in the sample. Barkla targets are made of light elements like  $\text{Al}_2\text{O}_3$  and  $\text{B}_4\text{C}$ , because these give the highest scattered radiation.

Barkla targets scatter a wide energy spectrum and can be used to measure a large range of elements. Generally Barkla targets measure the heavier elements.

### 4.5.3 Bragg targets

Bragg targets are crystals that reflect only one specific energy in a certain direction. By mounting the crystal between the tube and the sample it is possible to select a single tube line to irradiate the sample, with no other radiation diffracted towards

the sample. This will reduce the background level and improve the detection limit. If the spacing of the planes in the crystal is such that the tube line is diffracted at an angle of  $90^\circ$ , it can be used in 3D optics as a perfect polarizer.

## 4.6 Detectors and multi channel analyzers

Different types of detectors are used in XRF. EDXRF mainly uses solid-state detectors where WDXRF uses gas-filled detectors and scintillation detectors. The EDXRF detector is a wide-range detector and measures all elements from Na up to U. Gas-filled detectors measure elements from Be up to Cu and the scintillation detector from Cu up to U. All these detectors produce an electrical pulse when an X-ray photon enters the detector, and the height of this pulse is proportional to the energy of the incoming photon. The pulses are amplified and then counted by a multi channel analyzer.

There are three important properties of detection systems: resolution, sensitivity and dispersion.

**Resolution** is the ability of the detector to distinguish between different energy levels. A high resolution means that the detector can distinguish between many different energies.

**Sensitivity** indicates how efficiently incoming photons are counted. If for instance a detector is very thin, incoming photons may pass it without producing a pulse. Sensitivity is high if the ratio of the number of pulses against the number of incoming photons is high.

**Dispersion** indicates the ability of the detector to separate X-rays with different energies. A high dispersion means that different energies are separated well.

## 4.7 Multi channel analyzer (MCA)

The MCA counts how many pulses are generated in each height interval. The number of pulses of a certain height gives the intensity of the corresponding energy. The ability of the detector and MCA to distinguish between different energies is called the resolution.



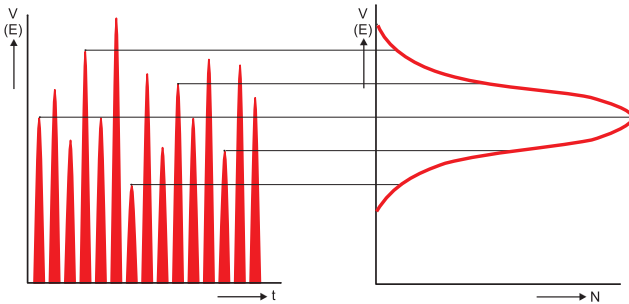

Figure 29. An MCA makes a histogram of the energy of the detected photons.

Strictly speaking, a WDXRF only has to count pulses and does not have to distinguish between their heights because the crystal has already selected X-rays with one specific energy. In practical situations the MCA for a WDXRF detector is able to distinguish 100 .. 255 different energy levels.

In EDXRF spectrometers, the detector and MCA are able to distinguish between 1000 and 16,000 different energy levels. This is sufficient to analyze spectra and to separate the radiation from the various elements in a sample.

**4.7.1 ED solid-state detector**

Figure 30 shows the basic design of a solid-state detector. It is constructed with a body of silicon, germanium or other semiconducting material. A beryllium window allows X-ray photons to enter the detector. On the front there is a dead layer and on the back there is a collecting plate.

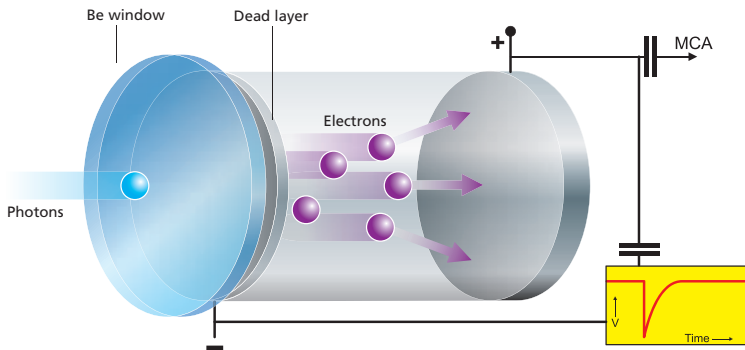

Figure 30. Basic design of a solid-state detector

Photons pass through the window and penetrate the body of the detector to

produce electron-hole pairs in the body. The number of electrons depends on the energy of the incoming photons. The higher the energy the more electrons will be produced.

A high voltage (1500 V) across the dead layer and the back means that the electrons are attracted to the back. When the electrons reach the back, the potential drops and gives a negative pulse. The depth of the pulse is proportional to the number of electrons and hence proportional to the energy of the incoming radiation. After amplification, a multi channel analyzer (MCA) counts the pulses.

#### 4.7.2 Gas-filled detector

Figure 31 shows the basic design of a gas-filled detector. It is constructed from a metal (often aluminium) cylinder at earth potential with a co-axial 50 mm tungsten anode wire running down its length. The anode wire is raised to a high voltage (1300 - 2000 V). A beryllium entrance window allows X-ray photons to enter the detector, which is filled with an inert counting gas (Ne, Ar, Kr or Xe, and occasionally He).

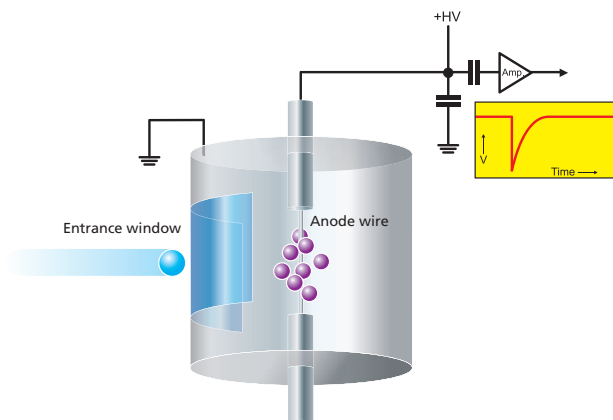

Figure 31. Basic design of a gas-filled detector

When an X-ray photon enters the detector it creates a small cloud of electrons, which are attracted by the wire. When the electrons reach the wire they cause a drop in voltage. This is registered as a negative pulse in the amplifier. The number of electrons is proportional to the energy of the incoming radiation, and hence the height of the pulse. A multi channel analyzer (MCA) counts the pulses produced by the detector.

The Be window must be thin to allow photons to enter the detector. If it is too thin, however, gas may penetrate the window. The detector is therefore sometimes

connected to an Ar gas bottle to replace the lost Ar. Such detectors are called flow detectors, and those with thicker windows to prevent gas from escaping are called sealed detectors.

### 4.7.3 Scintillation detector

Figure 32 shows the basic design of a scintillation detector. It consists of four main parts: a beryllium window, NaI scintillator crystal and a photo multiplier tube with Sb/Cs photo cathode.

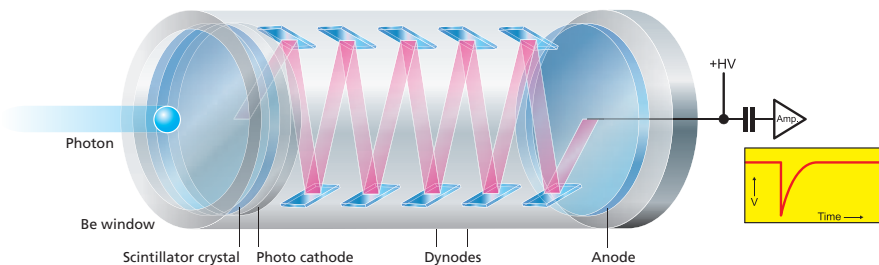

Figure 32. Basic design of a scintillation detector

X-ray photons pass through the beryllium window and hit the scintillator crystal, which produces a blue light flash. The light photons travel into the photomultiplier tube and impact on the photo cathode producing a burst of electrons, which are accelerated through a series of dynodes to the anode. When the resulting electrons reach the anode they cause a drop in voltage. This is registered as a negative voltage pulse in the amplifier. The number of electrons is proportional to the energy of the incoming radiation, and hence the height of the pulse. A multi channel analyzer (MCA) counts the pulses produced by the detector.

## 4.8 Escape peaks and pile-up peaks

Detectors suffer from two artefacts: escape peaks and pile-up peaks. The atoms in the detector (Ar, Si, Ge) will also emit their own characteristic radiation when hit by the incoming X-rays. Due to this, the incoming X-rays will lose a part of their energy, which is equivalent to the energy of the line of the detector element. For Si this is about 1.7 keV, for Ge 10 keV and for Ar about 3 keV. Besides counting photons with the initial energy, the detector will also therefore count a fraction with a lower energy. In the spectrum this will result in two peaks: a main peak and an escape peak.

Pile-up or sum peaks are the result of two photons entering the detector simultaneously. Both photons will produce a cloud of electrons, but they are detected as one large cloud. The energy detected is equivalent to the sum of the two initial energies. Figure 33 shows the production of escape and sum peaks in a Ge detector.

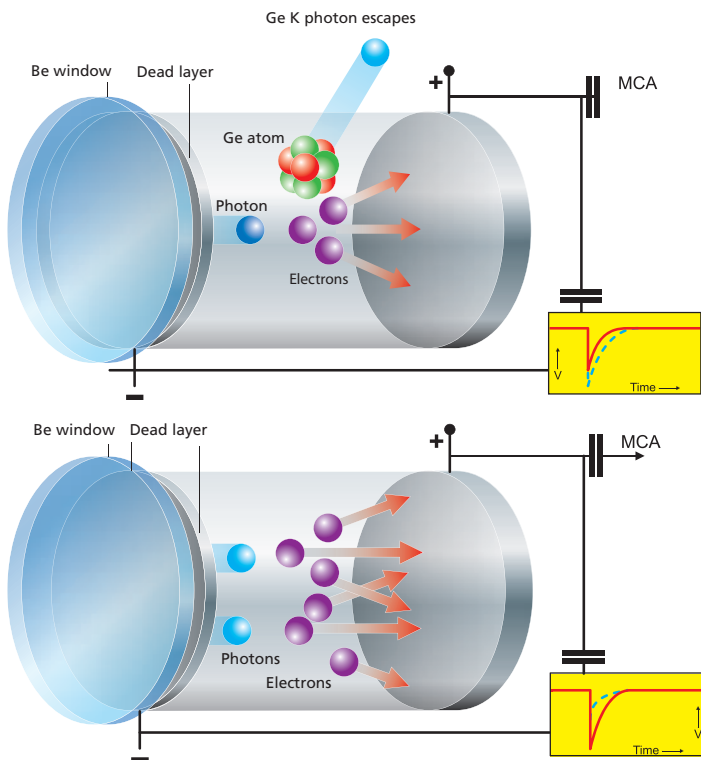

Figure 33. Production of escape (top) and sum peaks (bottom)

Pile-up peaks and escape peaks appearing in a spectrum can interfere with other peaks, or lead to wrong conclusions about the elements present in the sample.

## 4.9 Comparison of different detectors

The resolution of gas-filled and scintillation detectors is very poor, and they are not suited for energy dispersive spectrometers. They can however be used in wavelength dispersive spectrometers because, in these instruments, the resolution is achieved by the diffraction crystal. The sensitivity depends on the type of detector and on the energy of the incoming X-rays. Gas-filled detectors have a high sensitivity for low energies and a low sensitivity to high energies and are so best suited to detecting lower energies. The opposite applies for scintillation detectors, which are better suited to high energies than to low energies. Solid-state detectors in general have a very low sensitivity to low energies and high resolution for the higher energies. EDXRF spectrometers commonly use solid-state detectors, while WDXRF spectrometers use a combination of gas-filled and scintillation detectors.

### 4.10 Filters

Filters are placed between the source and the sample. They reduce the intensity of interfering lines and background, and hence improve the signal-to-noise ratio. In 2D optics, a fraction of the scattered tube spectrum reaches the detector and will be present in the measured spectrum. In some cases the tube lines of the spectrum interfere with lines coming from the sample (for example, the Rh *K* lines coming from the tube can interfere with the Ag and Cd *K* lines coming from the sample). By mounting a filter between tube and sample, the tube lines are absorbed and the lines coming from the sample are not. An example of a spectrum is given in Figure 34.

Figure 35 shows that the background radiation can be reduced more than the analytical lines. Then, the analytical lines can be determined with higher precision, and with better detection limits. Commonly used filter materials are aluminium and brass with a thickness between 100 and 1000  $\mu\text{m}$ , depending on the tube lines that have to be filtered out.

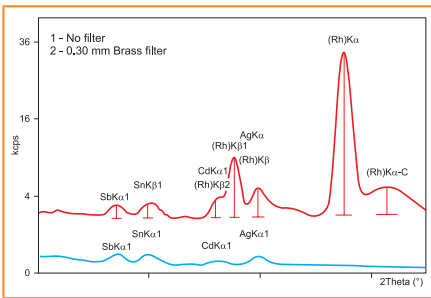

Figure 34. Filter used to filter tube lines and background

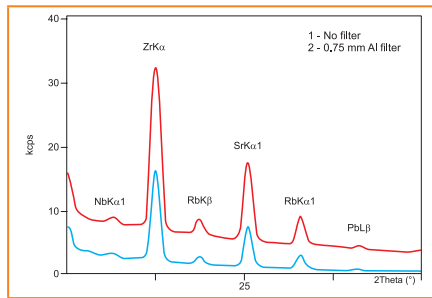

Figure 35. Filter used to reduce background and improve detection limit

If the intensity is too high for the detector and it would become saturated, a filter can absorb part of the radiation to prevent saturation.

### 4.11 Diffraction crystals and collimators

A crystal can be seen as a stack of thin layers all having the same thickness, as shown in Figure 36. If a parallel beam of X-rays falls on the crystal, the first layer reflects a fraction of the X-rays. The remaining radiation penetrates the crystal and is reflected by the subsequent layers. If the difference in path length between reflections from layers is a multiple of half the wavelength of the radiation, the two reflected beams vanish. If the difference is exactly an integer times the wavelength, the two reflected beams reinforce. The difference in path length is an integer times the wavelength if the following relation, called Bragg's law, holds:

$$n \cdot \lambda = 2 \cdot d \cdot \sin(\theta)$$

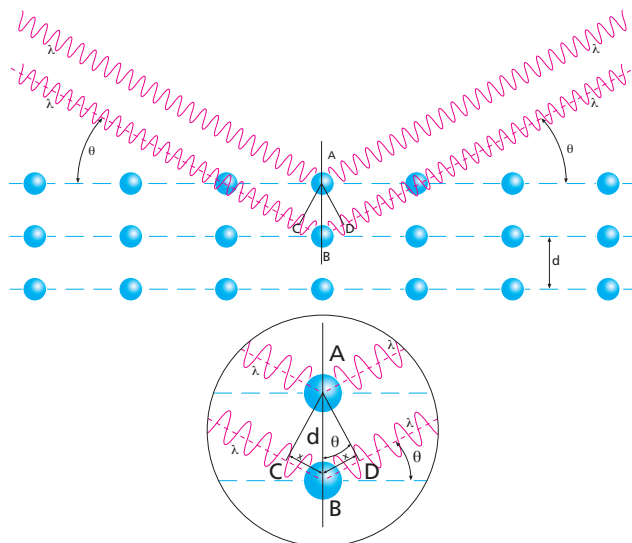

Figure 36. Demonstration of Bragg's law

At an angle  $\theta$ , all reflected radiation with a wavelength  $\lambda$  and obeying Bragg's law are 'in phase' and add up. All other wavelengths at the same angle will vanish.

A detector placed at angle  $\theta$  can therefore measure the intensity of the corresponding wavelength. Reflected wavelengths obeying Bragg's law for  $n=1$  are called first-order reflections, for  $n=2$  second-order etc. Note that, at a specific angle, radiation will be visible with wavelength  $\lambda$ ,  $\lambda/2$  and  $\lambda/3$ , but the detector will be able to distinguish between them.

Crystals are used to separate the characteristic radiation coming from a sample. Crystals can be naturally grown like LiF and Ge crystals but also a stack of deposited layers of W, Si, Mo, Sc or other elements. To cover all elements more than one crystal with different 2-d values are required.

At any specific angle, only radiation with a wavelength obeying Bragg's law is reflected. Radiation with slightly different wavelengths will be reflected at slightly different angles, but will still reach the detector and will interfere with the energy to be measured. A collimator, which is a set of parallel plates, is used to obtain a parallel X-ray beam that falls exactly at the required angle on the crystal. The primary collimator is placed between the sample and the crystal, and a secondary collimator can be placed between the crystal and detector.

## 4.12 Lens

Lenses are used in XRF to focus X-rays on a small spot or to receive only fluorescence from a small spot. Visible light has a refractive index higher than 1, so a convex glass can be used to focus light. X-rays have a refractive index just below 1, so to achieve the same effect the lens should be concave. Because the refractive index is very close to 1, the focal distance is long (about 1 m), making it unsuitable for practical use.

Another way to focus X-rays is to use capillaries made of carefully bent hollow glass fibers. (Because the difference in refractive index, visible light would require solid glass fibers). A mono-capillary has one fiber and a poly-capillary has a group of fibers. The X-rays are scattered in the fibers and all focused on one spot as shown in Figure 37.

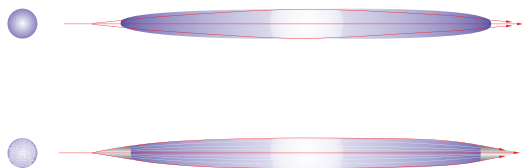

Figure 37. Mono- (top) and poly-capillary (bottom)

The focal distance and the transmission of the lens is not the same for all energies.

Very low energies are absorbed by the lens and very high energies are not focused but just pass through the lens.

## 4.12 Masks

A mask is a plate with a hole in it. A tube irradiates the sample, but also the cup in which the sample is placed. This cup will also emit its characteristic radiation, but this must not reach the detector or it will interfere with the radiation coming from the sample. A mask is placed between the sample and the detection system so that the detector 'sees' only the sample.

## 4.13 Spinner

Samples are not always perfectly homogeneous, and scratches on the surface may also influence measurements. A spinner rotates the sample during the measurement to even out effects of non-homogeneity and scratches.

#### 4.14 Vacuum and helium system

The source, sample and detection system are mounted in a vacuum chamber. Air will absorb tube radiation, especially low-energy radiation. This would make analysis of light elements impossible since all X-rays would be absorbed by the air and not reach the detector. Liquids and wet powders cannot be measured in a vacuum because they would evaporate. These types of sample are usually measured in a helium-filled spectrometer. Helium absorbs the radiation of the light elements, up to about fluorine, so it is not possible to measure these elements in liquids. Helium does not, however, affect the radiation from heavier elements.



## 5. XRF analysis

A good analysis starts with a well-prepared sample and a good measurement. This section describes how different sample types are prepared, and how they are measured accurately.

After a sample is measured, it is analyzed. This is done in two steps: Qualitative analysis followed by quantitative analysis. Qualitative analysis determines which elements are present and their net intensities from the measured spectra. In many routine situations, the elements in the sample are known and only the net intensities need to be determined. The net intensities are used in the quantitative analysis to calculate the concentrations of the elements present.

EDXRF and WDXRF often use slightly different methods for qualitative analysis. In EDXRF the area of a peak gives the intensity while in WDXRF the height of the peak gives the intensity. Both methods would work for EDXRF and WDXRF, but both have their specific advantages and disadvantages.

### 5.1 Sample preparation

Often, only a small sample of material is analyzed, for instance in a steel plant a small disk represents the full furnace contents. The sample must be representative of the entire material, and so must be taken very carefully. Once taken, it must also be handled carefully. The sensitivity of modern spectrometers is so high that they even detect fingerprints, which can disturb the analysis. Another basic requirement is that a sample must be homogeneous. Spectrometers only analyze the sample's surface layer, so it must be representative of the whole sample.

Most spectrometers are designed to measure samples that are circular disks with a radius between 5 and 50 mm. The sample is placed in a cup, and the cup is placed in the spectrometer. Special supporting films allow the measurement of loose powders and liquids. Different sample types are discussed below.

#### 5.1.1 Solids

Solids require only a minimum of sample preparation. In many cases, cleaning and polishing are sufficient. Metals may oxidize when exposed to air, so they are often ground or polished before they are measured to remove the rust.

#### 5.1.2 Powders

Powders can be placed on a supporting film and measured directly. Another technique is to press them under very high pressures (20,000 kg) into a tablet. A binding material is sometimes added to improve the quality of the tablet. The tablet is then measured and analyzed. If a binding material is used, this has to be taken into account in the analysis because it does not belong to the initial sample. Care should be taken that the sample is homogeneous.

### 5.1.3 Beads

Powder together with a binding additive called flux can also be melted (1000°C - 1200°C) into a glass sample called a bead. This sample is homogenous and can be measured directly. Because of the melting process, a part of the sample can evaporate as H<sub>2</sub>O or CO<sub>2</sub> so the sample loses part of its contents. Elements like S, Hg and Cd are also candidates for leaving the sample when heated. This loss is called loss on ignition (LOI).

Weighing the sample before and after fusion helps to determine the total LOI. The analysis should take into account the flux used and the LOI. Flux materials mostly contain light elements like Li<sub>2</sub>B<sub>4</sub>O<sub>7</sub>, so they cannot be measured. To correct for this, the analyst must take into account which, and how many, flux materials are being used.

### 5.1.4 Liquids

Liquids are poured into special cups with supporting films. Diluents are sometimes added to obtain sufficient liquid. Liquids cannot be measured in vacuum because they would evaporate; measuring in air is possible, but the air absorbs much of the radiation and makes it impossible to measure light elements. The spectrometer chamber is therefore filled with He gas - liquids will not evaporate and hardly any radiation is absorbed.

### 5.1.5 Material on filters

Filters used to filter air or liquid can be analyzed using XRF. The filter contains only a very small amount of the material to be analyzed. Filters do not require specific sample preparation and can be analyzed directly.

## 5.2 XRF measurements

XRF is a very sensitive technique and samples must be clean. Even fingerprints on a sample can affect the result of the analysis. For accurate results, the spectrometer (for example, the kV settings of the tube or the detector settings) is tuned to the elements to be analyzed. Bad settings can lead to poor results. In EDXRF a whole spectrum is measured simultaneously and the area of a peak profile determines the concentration of an element. Measuring the height of the peak profile is an alternative, but a lot of information would be lost because the area of a peak profile is less sensitive to noise than the height of the same peak. In WDXRF it is common practice to measure only at the top of the peak profile. The positions of the peaks are known and measuring only at the top position gives the best accuracy and the lowest measuring time.

### 5.2.1 Optimum measurement conditions

'Optimum' can be defined in many different ways, and the definition depends on the criteria used. The criteria can be highest intensity, lowest background, minimum line overlap and many others. A high intensity and low background have the advantage that lines can be detected and measured accurately and quickly. Minimum line overlap has the advantage that the intensity of the lines can be

determined directly, without sophisticated mathematical techniques. Weak lines can also be difficult to detect on the tails of strong lines.

The maximum intensity of a line is achieved if the energy of the incoming radiation is just above the absorption edge of that line. In WDXRF systems and EDXRF systems with direct excitation, this can be done by applying a voltage to the tube so that the largest part of the tube spectrum (continuum or tube line) has an energy just above the absorption edge of the analytical line.

In EDXRF systems using secondary targets, it is done by using a target that has a fluorescent line with an energy just above the absorption edge of the analytical line. The voltage applied to the tube is such that the spectrum of the tube excites the element(s) in the target optimally, according to the same principles described for WDXRF systems. If no such target is available, a Barkla target is used to scatter the total tube spectrum. The tube voltage is selected so that the largest part of the tube spectrum has an energy just above the absorption edge of the analytical line.

Line overlap occurs when the line of one element overlaps the line of another element. The interfering line can come from an element in the sample, but also from an element in the tube, crystal, secondary target, or any other component in the optical path.

High resolution and/or dispersion achieve minimum line overlap. In WDXRF spectrometers, the crystal and collimator have a large effect on the line overlap, which can be minimized by selecting the proper crystal and collimator. In EDXRF spectrometers, the detector and MCA settings have a large effect on the resolution and must be selected carefully. In some cases it is also worth measuring a weaker line of an element if a strong line is overlapped and the weaker line is not. For spectrometers using secondary targets, the selection of the proper target is essential. Scattered target lines can interfere with the lines of the sample so selecting the target that gives the lowest interference is advisable. Using a target that only excites the elements of interest and not elements that give interfering lines helps to reduce the line overlap.

## 5.3 Qualitative analysis in EDXRF

The first step in the analysis is to determine the top positions and the areas of the line profiles. The positions of the tops represent the presence of elements and the areas represent the intensities of the lines. Where the elements in a sample are known a priori, only the intensities need to be determined. The quantitative analyses require net intensities, meaning that the background must be subtracted from the spectrum.

### 5.3.1 Peak search and peak match

Peak search and peak match are used to find which elements are present in the sample.

Peak search uses a mathematical technique to find the peaks in a spectrum. Peak match determines the elements to which the peak profiles belong. This is done by comparing the positions of the peaks to a database holding the positions of all possible lines.

### 5.3.2 Deconvolution and background fitting

Figure 38 shows an example of a spectrum, with two peak profiles and a background. A spectrometer will measure the sum of the background and the profiles. In this example, the profiles don't overlap and the area of both can be determined without problems.

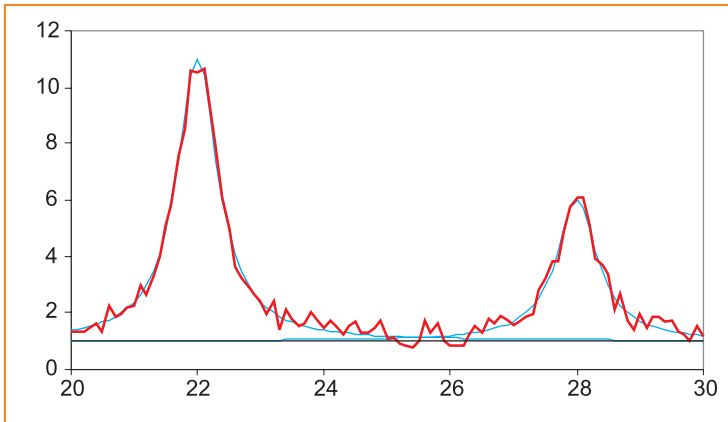

Figure 38. A spectrum with two peak profiles on a background

In other cases, peak profiles can overlap as shown in Figure 39.

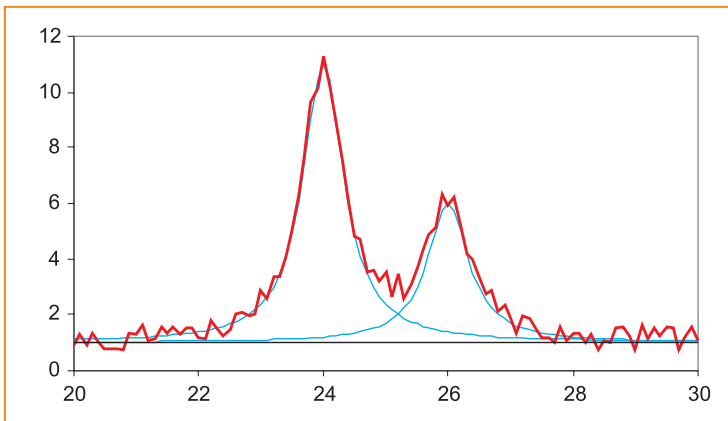

Figure 39. Two overlapping peaks and their sum

Deconvolution is used to determine the area of the individual profiles. The measured spectrum is fitted to theoretical profiles. The area of these profiles is changed, but keeping the shape fixed, until the sum of all the profiles gives the best fit with the measured spectrum. One way would be to try all possible combinations of profiles, but this would take a long time to find the best fit. Instead, a mathematical method called least squares fitting finds the best fitting peak profiles, but this can still be time-consuming. Theoretical calculations are also used to find the best fit. From theory, it is possible to calculate the ratios between groups of line intensities. This reduces the number of free parameters, finding the best fit more quickly.

The background has to be taken into account when fitting the peak profiles. First stripping the background, and fitting the profiles to the resulting net spectrum can do this. It is also possible to fit background and peak profiles to the measured spectrum in one process.

Mathematically it is formulated as find the heights  $height_p$  and widths  $width_p$  of all the peak profiles described by the function  $P_e$ , that minimizes the following sum:

$$\sum_{e=1}^{energies} \left( R_e^m - B_e - \sum_{p=1}^{profiles} P_e(height_p, width_p) \right)^2$$

In this equation  $R_e^m$  is the measured intensity in energy e,  $B_e$  the background at energy e.

## 5.4 Qualitative analysis in WDXRF

### 5.4.1 Peak search and peak match

As with EDXRF, peak search and peak match are used to discover which elements are present in the sample. Once again, peak search finds the peaks, and peak match determines the associated elements by referring to a database.

### 5.4.2 Measuring peak height and background subtraction

In WDXRF it is common practice to measure the intensity at the peak of a line and at a few background positions close to the peak. The positions must be chosen carefully and must avoid other peaks. The background under the peak is determined by interpolating the intensities measured at the background positions.

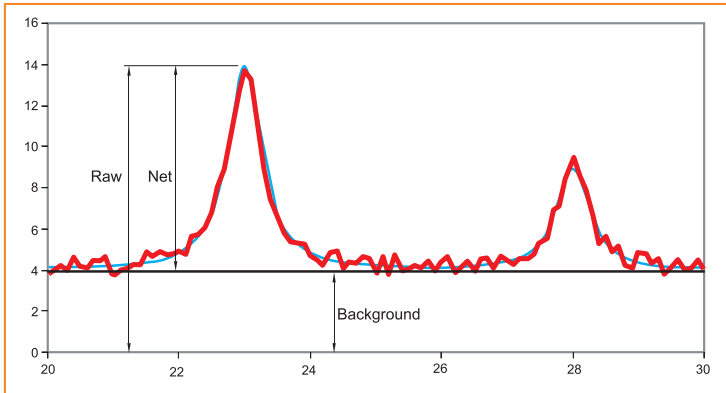

Figure 40. Determination of net intensity

### 5.4.3 Line overlap correction

Figure 41 shows two overlapping lines and their sum. Here, the height of the peak cannot be determined as the raw intensity minus the background.

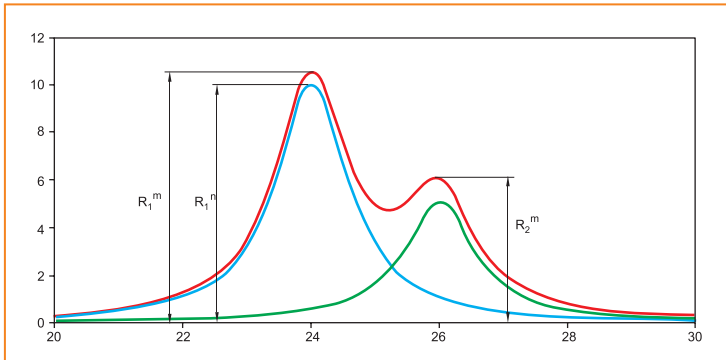

Figure 41. Two overlapping peaks and their sum

The intensity measured at position 1 is the sum of the net height of peak 1 and a fraction of peak 2, and vice versa. Mathematically this can be written as

$$R_1^m = R_1^n + f_{12} \cdot R_2^n$$

$$R_2^m = f_{21} \cdot R_1^n + R_2^n$$

This is a set of 2 linear equations, and the net intensities of both peaks can be calculated if the factors  $f_{12}$  and  $f_{21}$  are known. These two factors can be determined using a reference sample that contains only element 1, and another containing only element 2. For element 2, such a sample will give a spectrum like that in Figure 42.

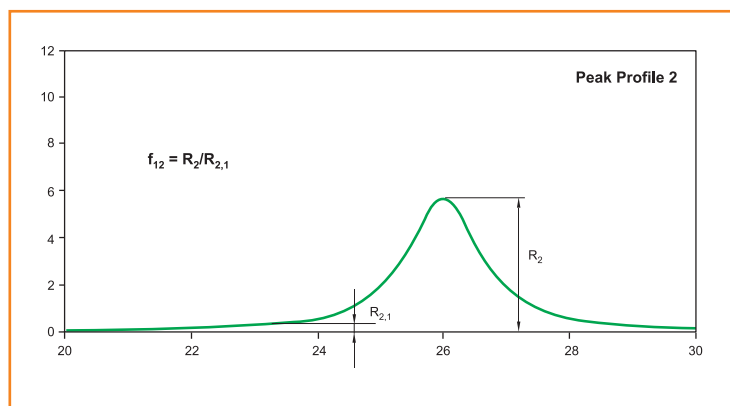

Figure 42. Determination of overlap factor

The fraction of peak 2 that overlaps with peak 1 is calculated as:

$$f_{12} = \frac{R_{2,1}}{R_2}$$

The overlap factor  $f_{21}$  of line 1 on line 2 can be determined in the same way.

## 5.5 Counting statistics and detection limits

The detector counts incoming photons, which is similar to counting raindrops. When it rains, the number of drops falling into a bucket in a second is not always exactly the same. Measuring for a longer time and calculating the average per second gives a more accurate result. If it is raining heavily, only a short time is required to give an accurate number of drops per second, but a longer time is needed if it is only raining lightly.

Raindrops have different sizes and counting all the drops with a specific size is equivalent to measuring the intensity of the radiation of one particular element in the complete spectrum. To tell whether there are more drops of one size than of another, sufficient drops have to be counted.

A histogram of the counted raindrops would look like Figure 43. The height of a bar corresponds to the number of drops counted having a specific size. The leftmost picture is the result after a short time, the middle after counting for longer and the rightmost after counting for a very long time. The longer the count, the clearer it becomes that the number of drops is not the same for each size.

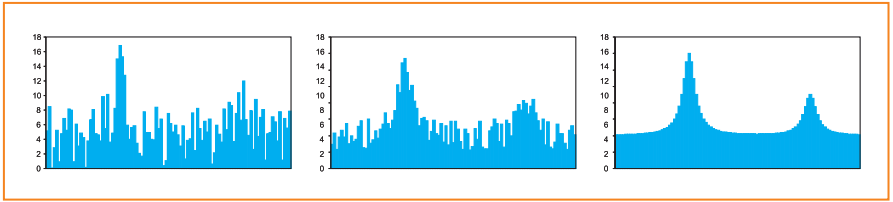

Figure 43. Number of raindrops counted per second

Now back to X-rays. To detect a peak of an element, it must be significantly above the noise (variation) in the background. The noise depends on the number of X-ray photons counted. The lower the number of photons counted, the higher the noise. The analysis is commonly based on the number of photons counted per second, but as above, the noise depends on the total number of photons counted. By measuring for a longer period, it is possible to collect more photons and hence reduce the noise.

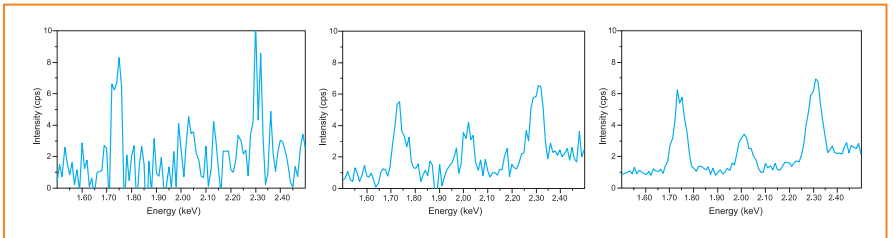

Figure 44. Spectra measured over different times

Figure 44 shows three spectra of the same material, but with different measurement times. In the first spectrum it is difficult to determine the peaks and their heights. In the second, the peaks are more prominent and in the third they can be clearly seen and their net heights can be determined accurately. A commonly accepted definition for the detection limit is that the net intensity of a peak must be 3 times higher than the standard deviation of the background noise. The standard deviation of the background noise equals the square root of the intensity (in counts), so elements are said to be detectable if:

$$\frac{N_p}{\sqrt{N_b}} \geq 3 \quad \text{where } N_p \text{ is the number of counts measured on the peak and } N_b \text{ is the number of counts measured on the background.}$$

With low backgrounds, low line intensities are sufficient to fulfil the requirement, so a low background gives low detection limits. 3D optics is used to reduce the background.



## 5.6 Quantitative analysis in EDXRF and WDXRF

Quantitative analysis is basically the same for EDXRF and WDXRF. The only difference is that in EDXRF the area of a peak gives the intensity, while in WDXRF the height of a peak gives the intensity. The exact same mathematical methods can be used to calculate the composition of samples.

In quantitative analysis, the net intensities are converted into concentrations. The usual procedure is to calibrate the spectrometer by measuring one or more reference materials. The calibration determines the relationship between the concentrations of elements and the intensity of the fluorescent lines of those elements. Unknown concentrations can be determined once the relationship is known. The intensities of the elements with unknown concentration are measured, with the corresponding concentration being determined from the calibration.

### 5.6.1 Matrix effects and matrix correction models

Ideally, the intensity of an analytical line is linearly proportional to the concentration of the analyte and, across a limited range, this is the case. However, the intensity of an analytical line does not only depend on the concentration of the originating element. It also depends on the presence and concentrations of other elements. These other elements can lead to attenuation or to enhancement.

Figure 45 (top) illustrates the absorption effect. To reach atoms inside a specimen, the X-rays from the source must first pass the atoms that are above them, and the fluorescence from the atoms must also similarly pass these atoms. These overlying atoms will absorb a part of the incoming radiation and a part of the fluorescent radiation. The absorption depends on which elements are present and on their concentrations. In general, heavy elements absorb more than light elements.

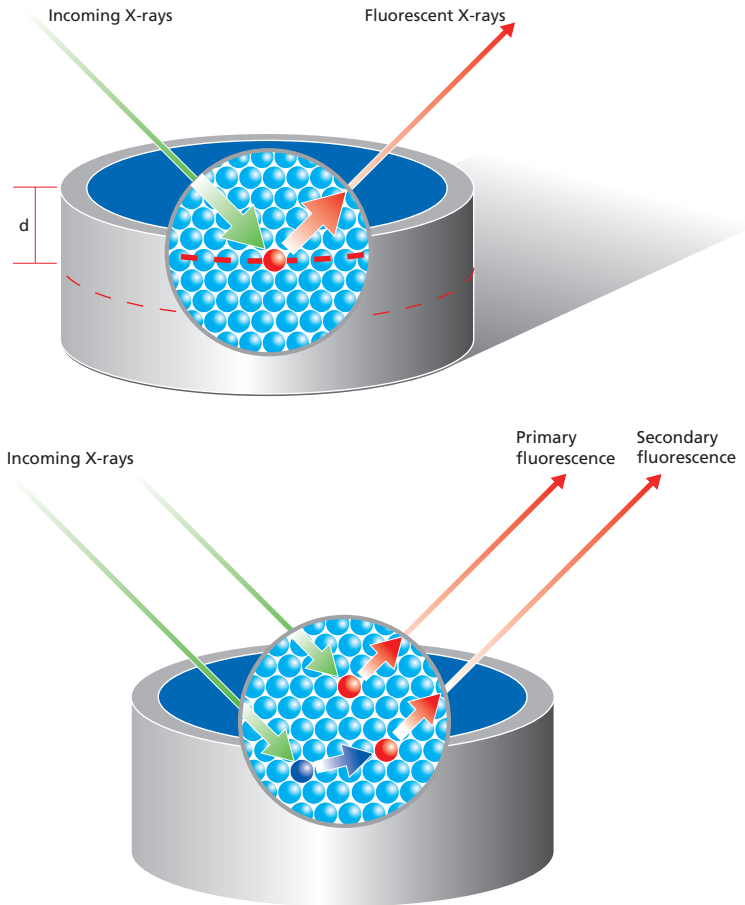

Figure 45. Absorption (top) and enhancement effects (bottom)

Figure 45 (bottom) shows the enhancement effect. An element is excited by the incoming radiation and in some cases also by the fluorescence of other elements. Whether or not this occurs and how large the effect is depends on the elements and their concentrations.

Across a limited range, the curve describing the relation between intensity and concentration can be approximated to a straight line given by  $C=D+E \cdot R$ , where  $D$  and  $E$  are determined by linear regression. This line can only be used for samples that are similar to the standards used, and across a limited range. Normally, it cannot be used for other types of samples. A better fit and a wider range is possible by adding more terms such as  $C=D+E \cdot R+F \cdot R^2$ , but the range will still be limited and only applicable to samples similar to the standards.

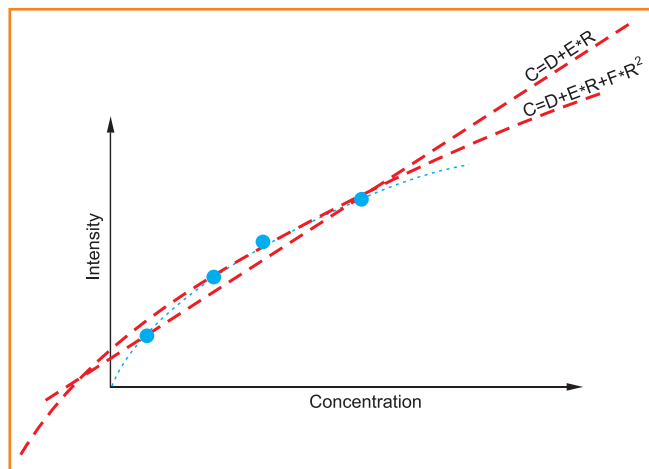

Figure 46. Calibration with linear and parabolic fit

Matrix correction models use terms to correct for the absorption and enhancement effects of the other elements. This is done in various ways, but they all, in one way or another, use the equation:

$$C_i = D_i + E_i \cdot R_i \cdot M_i$$

or

$$C_i = (D_i + E_i \cdot R_i) \cdot M_i$$

This booklet discusses the first equation, but the method is also applicable to the second equation. M is the matrix correction factor, and the difference between the models lies in the way they define and calculate M.

### 5.6.1.1 Influence of coefficient matrix correction models

These models have the shape:

$$C_i = D_i + E_i \cdot R_i \cdot [1 + \text{corrections}]$$

The corrections are numeric values depending on the concentrations and/or intensities of the matrix elements. Many people have suggested ways to define and model the corrections, and models are commonly named after the person(s) who proposed them.

A commonly used method has been proposed by and named after, De Jongh, and is given by:

$$C_i = D_i + E_i \cdot R_i \cdot \left[ 1 + \sum_{\substack{j=1..n \\ j \neq e}} \alpha_j \cdot C_j \right]$$

The  $\alpha$ s are numeric values that indicate how much element j attenuates or enhances the intensity of the analyte i. Because the sum of all concentrations in a specimen equals 1, one element can be eliminated, indicated by  $j \neq e$ . The element being eliminated is often the major component like Fe in steel or Cu in copper-based alloys. The values of the  $\alpha$ s are calculated by theory using 'Fundamental Parameters' (see also Section 5.6.1.2). After the  $\alpha$ s have been calculated, at least two standards are required to calculate D and E (only one if D is fixed). Instead of calculating the values of the  $\alpha$ s from theory, it is possible to calculate them using regression. Then, a set of different standards is measured and the values of D, E and the  $\alpha$ s are calculated. The equations can be extended with additional correction factors leading to more comprehensive models. The top picture of Figure 47 shows a calibration of Ni in steel without any corrections and the lower picture shows the same when corrections are applied.

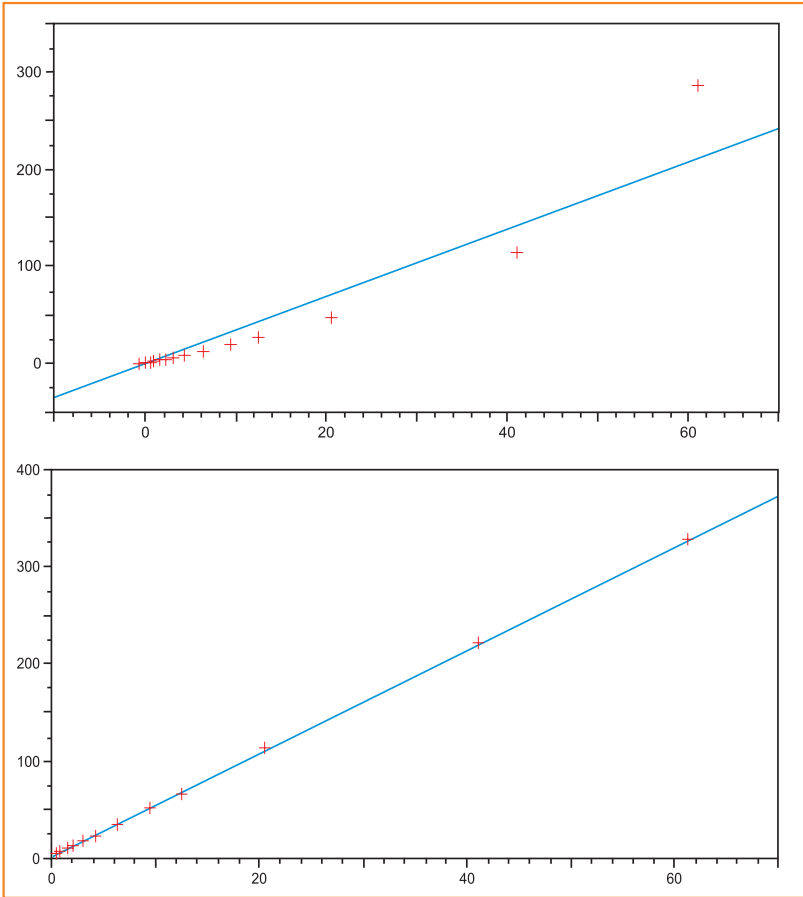

Figure 47. Calibration of Ni without correction (top) and with alpha corrections (bottom)

### 5.6.1.2 Fundamental Parameter (FP) matrix correction models

Fundamental Parameter models are based on the physics of X-rays. In the 1950s, Sherman derived the mathematical equations that describe the relationship between the intensity of an element and the composition of a sample. This equation contains many physical constants and parameters that are called Fundamental Parameters. The Sherman equation is used to calculate the values of the matrix correction M fully by theory and the model becomes:

$$C_i = D_i + E_i \cdot R_i \cdot M_i$$

At least two standards are required to calculate D and E, or just one if only E has to be calculated. M is calculated for each individual standard, and the factors D and E are determined for all elements.

The matrix factors M can only be calculated accurately if the full matrix is known, because all absorption and enhancements have to be taken into account. The calculations are quite complicated and require a powerful computer which, until recently, made these models unsuitable for routine operations. Because FP accounts for all effects, it can be used over virtually the full concentration range and for all types of samples as long as the majors are known. Figure 48 shows the results using the same FP calibration for samples with a very wide concentration range.

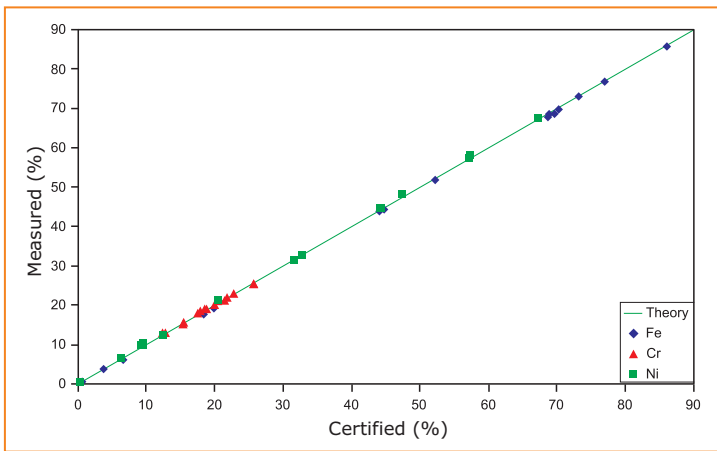

Figure 48. Results of FP analysis for various samples

### 5.6.1.3 Compton matrix correction models

The Compton method is an empirical one. The intensity of a Compton scattered line depends on the composition of the sample. Light elements give high Compton scatter, and heavy elements low Compton scatter, which is used to compensate for the influence of the matrix. The model is:

$$C_i = D_i + E_i \cdot \frac{R_i}{R_c}$$

The Compton line can be a scattered tube line, or a line originating from a secondary target if 3D optics are used. The top picture of Figure 49 shows a calibration without any corrections and the lower picture shows it after Compton correction is used.

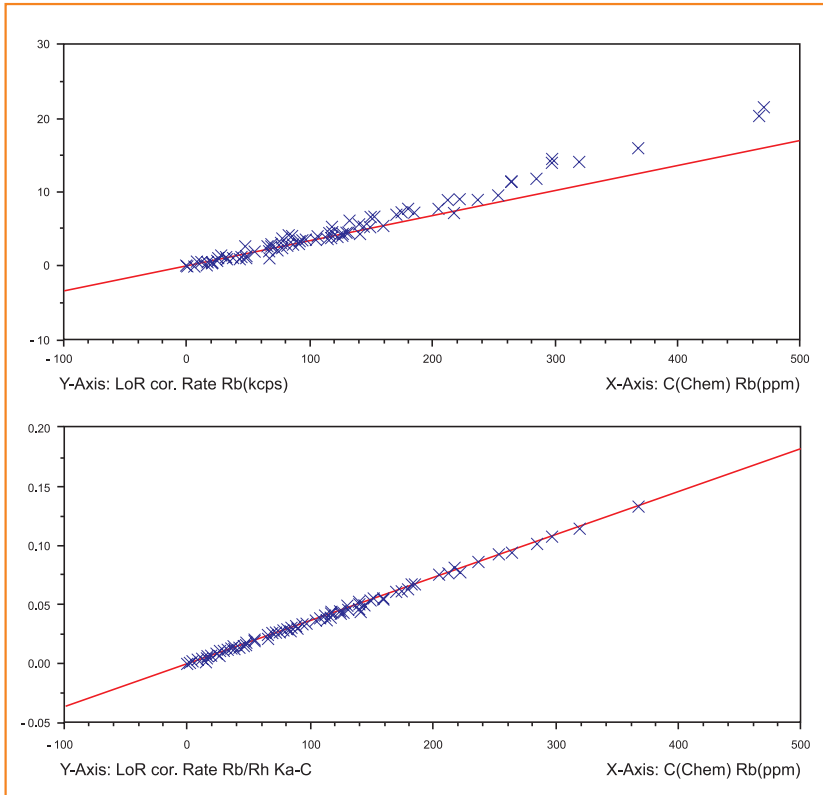

Figure 49. Calibration without (top) and with Compton correction (bottom)

### 5.6.2 Line overlap correction

Sections 5.3.2 and 5.4.3 explained how overlapping lines were resolved: by subtracting a fraction of the overlapping peak from the peak of interest. The fractions were determined by measuring dedicated standards. Another method is to determine the overlap factors by regression. The calibration model is extended with terms that describe the line overlap:

$$C_i = D_i + E_i \cdot \left( R_i - \sum_{\substack{\text{overlapping} \\ \text{lines } j}} f_{ij} \cdot R_j \right) \cdot M_i$$

The overlap factors  $f_{ij}$  are determined by regression. The problem with this equation is that it can be non-linear, which makes it difficult to calculate the

factors. If the calibration is limited to a small range, and when the variation in M is small, it can be approximated by:

$$C_i = D_i - \sum_{\substack{\text{overlapping} \\ \text{lines } j}} f_{ij} \cdot R_j + E_i \cdot R_i \cdot M_i$$

This is a linear equation, and it is mathematically easy to calculate the overlap factors  $f_{ij}$  and the other calibration parameters simultaneously.

These methods require that the overlapping intensities be measured. In EDXRF this is not a problem because the whole spectrum is generally measured. In WDXRF, often only the lines of the elements of interest are measured and not the overlapping lines. The intensity of the overlapping lines is, over a limited range, proportional to the concentration of the originating element. The following equation can therefore be used:

$$C_i = D_i - \sum_{\substack{\text{overlapping} \\ \text{lines } j}} f_{ij} \cdot C_j + E_i \cdot R_i \cdot M_i$$

### 5.6.3 Drift correction

The stability and reproducibility of spectrometers is high, but long-term drift is unavoidable. The tube and the detector degrade over time and the response of the other components can also change over time. Because of this drift, a calibration is not valid after a certain period of time. Calibrating anew can be time-consuming, and an alternative is to apply drift correction. Here, one or more special monitor samples are measured, and the relative change in intensity of the monitor samples is also applied to the samples being analyzed.

### 5.6.4 Thin and layered samples

Thin samples require special treatment. For thick samples, the intensity corrected for matrix effects is linearly proportional to the concentration and does not depend on the thickness of the sample. This is because only radiation coming from a layer close to the surface can leave the sample and reach the detector. Radiation coming from deeper layers is not detected, and making the sample thicker will have no effect on the measured intensity.

The situation is different for thin samples. As long as the radiation from the bottom of the sample can still pass through the sample and reach the detector, it will affect the measured intensity. If the measured intensity of a thin sample is lower than the intensity of a standard, it is not possible to tell whether the concentration of the analyte is lower or whether the sample is thinner than the standard.

The Compton correction model will correct for finite thickness. The Compton line



and the analytical line approximately have the same thickness dependency. By dividing the intensity of the analytical line by the intensity of the Compton line the thickness dependency vanishes.

If the thickness of the sample is known, it can be taken into account in the Fundamental Parameter calculations and it again becomes possible to calculate the concentration of the analyte.

With Fundamental Parameters it is even possible to calculate the thickness and composition of layered samples and coatings. Examples are optical coatings, magnetic recording materials, semiconductor wafers. The Fundamental Parameters method starts with an initial guess of the thickness and composition and iteratively changes the thickness and composition until the observed intensities are equal to the predicted intensities.

## 5.7 Analysis methods

Analysis uses the same equations as used for the calibration. In the calibration, the D, E and correction factors are the parameters that have to be determined. The concentrations are known because standards with known composition were used. In the analysis, the opposite is true. The D, E and correction factors are known, and the concentrations are the unknowns that have to be determined. Often this is done by iterative methods.

The process starts with an initial guess at the concentrations, and these concentrations are substituted in the right hand side of the equations. This gives new values for the concentrations that are substituted in the right-hand sides, again giving new values for the concentrations. This process is repeated until the concentrations converge to limiting values. The result of the final iterations is assumed to be the composition of the sample:

$$C_1 = D_1 + E_1 \cdot R_1 \cdot M_1(C_1..C_n, R_1..R_n)$$

$$C_2 = D_2 + E_2 \cdot R_2 \cdot M_2(C_1..C_n, R_1..R_n)$$

*etc.*

### 5.7.1 Balance compounds

It is sometimes not required or impossible to measure all compounds. For example, in steel, Fe is not measured, and compounds like H<sub>2</sub>O can also not be measured effectively (H cannot be measured, and O occurs in many other compounds). If all the other compounds are measured or known, the remaining compound can be determined, because the sum of all concentrations must add up to 100%. The compound that is determined by the difference calculation is often called the balance (compound).

### 5.7.2 Normalization

Due to inaccuracies in the calibration, the sample preparation or in the measurement, the sum will not be exactly 100%. Some concentrations are overestimated and others are underestimated. If all compounds are analyzed, the concentrations can be normalized to 100% and the average deviations will, in many cases, be less than without normalization.

## 5.8 Standardless analysis

The quantitative analysis described in the previous section requires standard samples for the calibration. If the coefficient models described in 5.6.1.1 are used, the calibration is only valid over a limited range and only for unknown samples that are similar to the standards. By using Fundamental Parameters instead of coefficient models, this can be extended to the full range. In both cases, however, the calibration determines the relation between the concentration of a compound and the intensity of an element. Compounds can be pure elements like Fe, Cu but also FeO or Fe<sub>2</sub>O<sub>3</sub>. If the calibration was done with FeO then the analysis will also determine the FeO concentration, but if a sample with Fe<sub>2</sub>O<sub>3</sub> is measured it is not possible to determine the concentration of this compound.

One way to make the calibration independent of the compounds is as follows:

1. The standards are entered as elements and/or compounds, but all concentrations are converted to element concentrations using the chemical formula of the compound and atomic weights of the elements.
2. The calibration is done per element, so the concentrations of the elements are calibrated against their intensities.
3. The concentration of the elements is determined for an unknown sample.
4. The element concentrations are converted to compound concentrations using the chemical sample, together with its chemical formula and the atomic weights of the elements.

In this way, the calibration is independent of the samples to be analyzed. All types of materials can now be used as standards as long as they contain the elements of interest. Because the standards can be chosen independently from the sample to be analyzed they are no longer called standards but reference samples, and the method is called standardless.

For the qualitative analysis, the composition of the sample is not important because it determines the intensities of radiation from elements and not from compounds.

The qualitative and quantitative analysis can be fully automated, making it possible to analyze all kinds of materials with a single calibration.

## 7. Index

### Symbols

2D optics 19  
2D spectrometers 19  
3D optics 19  
3D spectrometers 19

### A

Absorption 13  
Absorption effect 49  
Amplification 33  
Amplifier 33  
Analysis depths 16  
Analysis methods 57  
Analyzing crystal 21  
Atomic number 14

### B

Background fitting 44  
Background noise 23  
Background profile 20, 23  
Background subtraction 45  
Balance compounds 57  
Barkla targets 30  
Beads 42  
Beryllium (Be) window 28  
Bragg's law 36, 37  
Bragg targets 30  
Bremsstrahlung 28

### C

Calibration 49, 51, 52, 53, 54, 55, 57  
Characteristic radiation 12, 15, 16, 17,  
21, 22, 24, 28, 30, 34, 38  
Chemical composition 9  
Coefficient matrix correction 51  
Coherent scatter 17  
Collimators 25, 36  
Compound 57, 58  
Compton 11, 17, 18, 54, 55, 56  
Concentration range 9, 54  
Continuum 28, 29  
Counting statistics 47  
Cup 38, 41, 42

### D

Deconvolution 44, 45  
De Jongh 52  
Detection limit 9, 27, 31, 36, 47, 48  
Detection system 21, 25, 31, 38, 39  
Diffraction crystal 25, 35, 36  
Direct excitation 23, 27, 43  
Dispersion 21, 31, 43  
Drift 56  
Drift correction 56

### E

Electromagnetic radiation 11  
Energy dispersive 9, 19, 21, 22, 23, 24,  
35  
Enhancement effect 15, 50, 51  
Environmental analysis 9  
Escape peaks 34, 35

### F

Filters 36, 42  
Fingerprint 13  
Finite thickness 56  
First-order reflections 37  
Flow detectors 33  
Fluorescence, Compton scatter 11  
Fluorescent radiation 11, 12, 16, 30, 49  
Fluorescent targets 30  
Fundamental Parameters 52, 53, 58

### G

Gadolinium (Gd) 28  
Gas-filled detectors 31, 35  
Goniometer 25, 27

### H

Heavy elements 18, 27, 30, 49, 54  
Helium system 39  
High atomic numbers 9  
Homogeneous 38, 41

### I

Incoherent scatter 17  
Indirect excitation 23, 24, 25  
Inert counting gas 33  
Interfering lines 36, 43  
IUPAC notations 14

**K**

K-shell 12, 13, 14

**L**

Layer 9, 15, 16, 32, 33, 36, 41, 56

Least squares fitting 45

Light elements 14, 18, 27, 30, 39, 42,  
49, 54

Line overlap 42, 43, 46, 55

Liquids 39, 41, 42

Loss on ignition (LOI) 42

L-shell 12, 13

**M**

Masks 38

Matrix 51, 54

Matrix correction models 49, 51, 53, 54

Matrix effects 49, 56

MCA 31, 32, 33, 34, 43

Monitor samples 56

Monochromatic radiation 22

Moving detector 25

M-shell 12

Multi channel analyzers 31

**N**

Net intensity 46, 48

Normalization 58

**O**

Optical path 19, 43

**P**

Path length 16, 36

Peak match 43, 45

Peak profile 9, 42, 44, 45

Peak search 43, 44, 45

Perpendicular reflections 20, 24

Pile-up peaks 34

Polarization 19, 20, 24

Powders 39, 41

Primary fluorescence 16

Pulses 31, 32, 33, 34

**Q**

Qualitative analysis 11, 41, 43, 45, 58

Quantitative analysis 11, 41, 49, 58

Quantum mechanics 14

**R**

Rayleigh scatter 11, 18

Reference materials 49

Reflection 20, 24, 36, 37

Reproducibility 9, 56

Resolution 27, 31, 35, 43

**S**

Sample preparation 9, 41, 42, 58

Scatter 11, 12, 17, 18, 20, 23, 24, 30, 43

Scintillation detectors 31, 35

Sealed detectors 33

Secondary fluorescence 16

Secondary target 22, 24, 25, 30, 43, 54

Sensitivity 27, 31, 35, 41

Sequential spectrometers 25

Side window tubes 29

Siegbahn notation 14

Signal-to-noise ratio 36

Simultaneous spectrometers 25

Solids 41

Solid-state detectors 31, 35

Spinner 38

Standardless analysis 58

Standards 9, 17, 50, 52, 54, 55, 57, 58

**T**

Target Transmission tubes 29

Thin samples 56

Transitions 15

Tube spectrum 36, 43

**U**

Unknown concentrations 49

**V**

Vacuum chamber 39

Very low concentrations 24

**W**

Wavelength dispersive 9, 21, 35

Weak peaks 24

Wet powders 39

**X**

X-ray tube 11, 21, 28, 29



ISBN: 90-9016758-7